

«

»

«
«

»

2001 .

»,

2015 .

• • ,
• • ,
• •

•
•

004.4(075.8)
32.97 73
72

(11 23 2015 .)

:

, . . . » , -
;

, . . . » , -
.

. .

72

: / . . , . . -

, . . . , 2016. – 212 . – («
», .52).

ISBN 978-966-337-418-5

. , -
,

« » , -
,

, -
-

MatLab.

, , ,
.

004.4(075.8)
32.97 73

© . . . ,
. . . , 2016

© , 2016

ISBN 978-966-337-418-5

.....	4
1.	7
2.	25
3.	32
3.1.	57
3.2.	66
3.3.	73
3.4.	88
4.	103
5.	111
SEMANTIC WEB	130
7. DATA MINING	
.....	137
8.	161
9.	172
9.1.	192
.....	207

.
 ,
 -
 -
 .
 ,
 -
 -
 :
 -
 -
 ,
 ;
 -
 ;
 -
 ,
 -
 ,
 ;
 -
 -
 ;
 -
 ,
 -
 ,
 ,
 ,
 ;
 -
 ,
 .

-
-
-
-

.

,

,

,

.

,

.

1

1. .
2. , .
3. , .
4. .
5. .
6. .
7. -

1.

, . -
- -
- , -
- : -
- , (, -
- ,) ; -
- , -
- , -
- , -
- : , -
- , -
- ; , -
- , -
- . , -
- , -
- , -
- .

—
.
—
, (—
,
,
)» « » « » , , —
, : —
, — , . : —
— , , —
, « ?» ; —
— , « ?» ; —
— , , ; —
— , ; —
— , , —
, , , , . —
, , , , , . —
— , , — —
; —
, —
.
: —
, , , ; —
, , , , . —

, , , -
 . (, -
 -, -,). : (), -
 ; , ;
 , ; -
 , , , -
 , , .
 , . , : , -, -,
 () (, -
 ,) . . - -
 () (, , -
) . -
 . : (-
 , ,); (-
 , ,); (, -
); , -
 . : (-
 , ,); (, ,
); (, ,
). , -
 , . -
 - « », -
 .
 :

2.

()

1) $D_1 -$

2) D_2 – (, ,);

3) D_3 – (, - , .

4) D_4 – , ;

5) D_5 – , () .

– , (, - ,) , « ».

– , : - - - - -

1) R_1 – , ;

2) R_2 – (- , .);

3) R_3 – – , - , - ;

4) R_4 – , ;

5) R_5 – , () .

3.

1)

« » ,

2)

« »,
.
« — », « — —
», « — »,
,
.

3)

« — », « — », « — » .;
,
,
,
— », « », « »
,
,
»;
»;

4)

,
, ()
,
,
,
,
— ,
.

4.

— — ,
— — (,
);
— — ();
— — ,
().

5.

, , -
-
, . -
, . ,
:
•
•
•
• ;
; ;
• ;
; -
; ;
, ; -
• ;
; ; -
, ;
• • ;
; ; -
• • ;
• ;
• ; ; -
• ; ; -
• • ;

» (« ») « - » (« »); « -
•

•

•

-

•

•

•

-

,

-

,

;

,

•

•

-

,

,

;

-

/

.

•

•

-

;

;

-

-

;

-

;

-

•

•

•

,

;

-

;

-

-

•

•

•

-

;

-

;

,

•

,

/

•

-

•

;

;

/ .

,

,

,

,

80-

«

»

,

,

,

.

,

,

»:

«

,

».

,

.

6.

1.

1

/			
1.	<p>• • • , • • •</p>	<p>, - - - -</p>	<p>, - - - -</p>
2.	<p>• • •</p>	<p>, : , , , - -</p>	<p>, , , - -</p>
3.	<p>•</p>	<p>, « - »</p>	<p>, -</p>

4.	<i>American Productivity & Quality Center</i>	, , , , - -	, , , - -
5.	.	: , , , - - - -	, , , - - -

:-
-
-
-
-
-
-
-
-
-
-
-
-

, , -
 . , -
 , -
 . -
 , , -
 , -
 .
 :
 () - -
 , , , , ,
 , , .
 , (, -
) . -
 , . -
 , -
 , -
 () , -
 ,
 .
 , -
 .
 , ,
 , - ,
 , : ,
 , . , -
 - , -
 , , ,

, , -
 , -
 (). -
 , . -
 - - -
 , -
 , -
 - -
 .
 , ,
 , ,
 .
 ()
 ,
 . ,
 , -
 , -
 , . -
 , -
 (), :
 1) (Data mining, Text Mining),
 ,
 ,
 ;
 2) (Document manage-
 ment), , , -
 ;
 3) (Collaboration) -
 ntranet, , -
 ;
 4) ;
 5) (Decision
 support) - , -
 , . -
 -
 :

. 1.1.

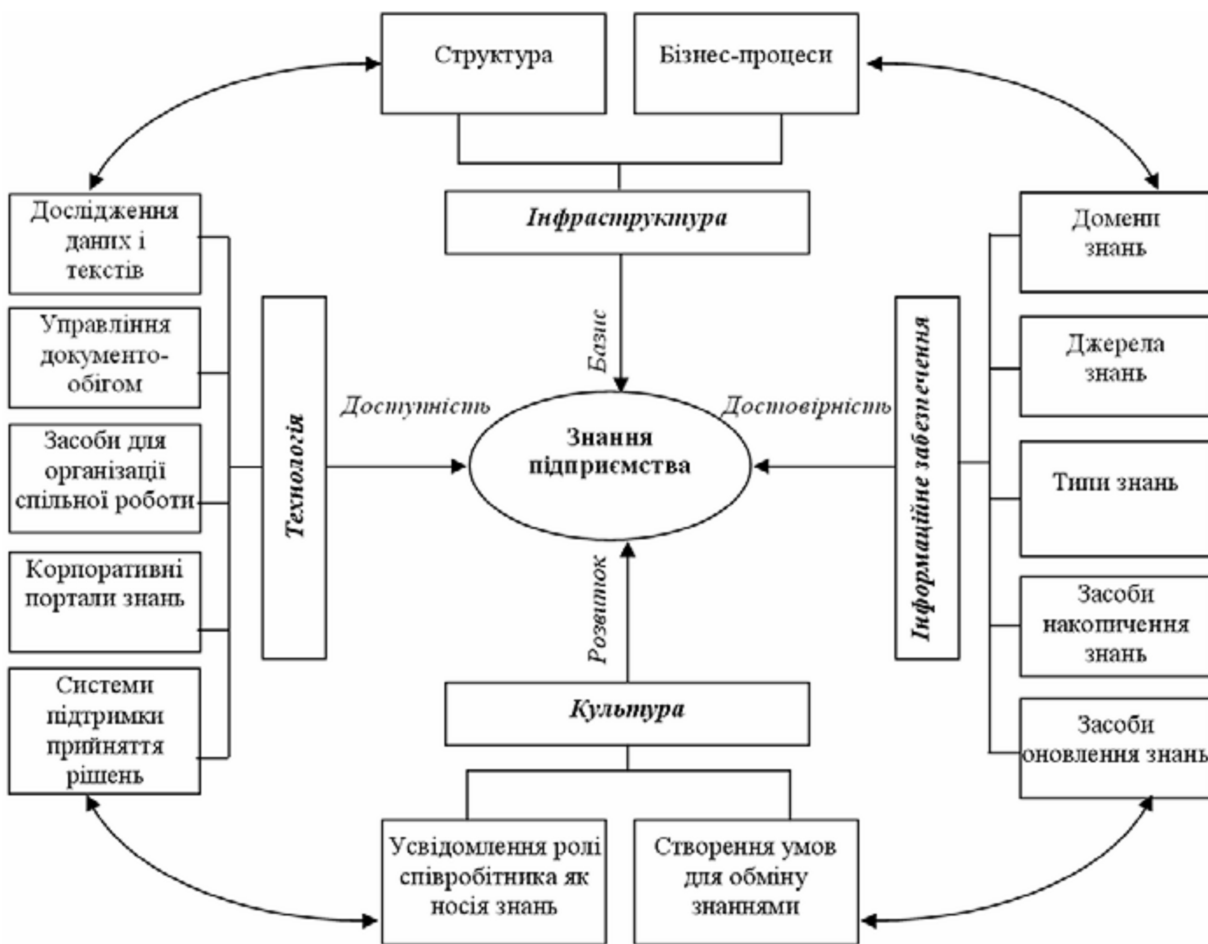

. 1.1.

7.

,
- , -
,
,
,
,
-
,
,
-
-
-
,
-
,
-
,
-
-
,
,
,
()
,
(),
.

- , , . -
 :
 - ;
 - ;
 - ;
 - .
 .
1. , ?
 2. ?
 3. -
 - ? 4. ?
 5. -
 - ? 6. -
 - ? 7. ?
 8. ?
 9. « »?
 10. -
?

2

1. .
2. .
3. .

1.

, . ,
(). — , .
— , .
.
,
, , , ,
, .

2.

- :
1. () ,
, , (,).
 2. () ,
.
,

3.

—
—
—
—

;
;
;
.

:

, ,
, ,
, .

—
—
—
—

$S = \langle B, F, A, R \rangle,$

—
F—
—
R—

,
();
;
, $A \subseteq F$;

, —

1.

2.
3.

:

—
—

.
,

—

—

« , ». , -
 . , « , -
 » « , -
 ».

.
 , -
 , -
 , , , -
 , , , -
 . , , -
 .

, -
 . :
 :

$$i : S; L; A \rightarrow B; Q ,$$

$i -$;
 $S -$, -

;
 $A \rightarrow B -$;

$Q -$, , -
 $B.$

:
 - -

, .
 - -

, (), -
 , -

.
 - « » -

— « » —
 . , —
 . , —
 . , —
 ()

. , , ,
 , , ,
 .

(arb), b — , r — —

$$H = \langle I, C_1, \dots, C_n, R \rangle,$$

I — ;
 $C_1, \dots, C_n, i = \overline{1, n}$ — , I;
 R — ,
 I, , $\{C_i\}$.
 , $\{C_i\}$:
 ,
 ,
 ,
 I.

(, -), « -
- », « - » .
 , -
» « », « » —
 , , .
 — ,
 . , , ,
 — ,
 ,
 : , -
 , .
 :
 — ;
 — , ;
 — , ;
 , .
 :
 — , , -
 , ;
 — , -
 ;
 — , -
 , -
 , -
 .

1979 . . .

« ' » (frame -)

$$f[\langle v_1, g_1 \rangle, \langle v_2, g_2 \rangle, \dots, \langle v_k, g_k \rangle],$$

$$f - ' ;$$

$$\langle v_i, g_i \rangle, i = \overline{1, k}, - i - , v_i - , g_i -$$

- - , -
- ;
- - ;
- - .

1.

?

-

2.

?

-

3.

?

4.

?

-

5.

?

6.

?

7.

?

- 1. , -
- 2. .
- 3. .
- 4. .
- 5. : .
- 6. .
- 7. .
- 8. .
- 9. .
- 10. Matlab.

1.

- -
-
, , -
-
, . -
-
, ,
.
-
.
.
.

International Fuzzy Engineering),

LIFE (Laboratory for

19

2.

$$X \subseteq R^1 -$$

(fuzzy set) A

X

$$(x, \mu_A(x)):$$

$$A = \{x, \mu_A(x) \mid x \in X, 0 \leq \mu_A(x) \leq 1\},$$

$\mu_A(x)$ -

x

A .

:

$$A = \{x_1 / \mu_A(x_1), x_2 / \mu_A(x_2), \dots, x_m / \mu_A(x_m)\} .$$

$x \in X$

$[0,1]$.

$$\mu_A(x) = \begin{cases} \max(0, (x_4 - x)/(x_4 - x_3), & x > x_3 \\ \max(0, (x - x_1)/(x_2 - x_1), & x < x_2 \\ 1, & x \geq x_2 \text{ and } x \leq x_3 \end{cases}$$

$x_1 < x_2 < x_3 < x_4$.

1

3.

« \tilde{X} », « \tilde{X} »). \tilde{X} (m , « \tilde{X} » ,

$$\tilde{X} = \{A_j \mid j = 1..m\}.$$

X .

$$A_j = \{x, \mu_{A_j}(x) \mid x \in X, 0 \leq \mu_{A_j}(x) \leq 1\}.$$

\tilde{X} :

$$\mu_{A_j}(x), \quad j = 1..m$$

X .

4.

, () ,
 , NOT, AND, OR.
 {0,1}.

[0,1] .

() $\mu \in [0,1]$.

A, B –

4.1. NOT – :
 $NOT A = A' = \{x, \mu_{A'}(x) | x \in X, \mu_{A'}(x) = 1 - \mu_A(x)\}$.
 $NOT(\neg)$ [0,1]:

$$\neg a : [0,1] \rightarrow [1,0].$$

4.2. AND (\cap) – , :
 $A AND B = A \cap B = T_{\cap}(\mu_A(x), \mu_B(x))$.

$$T_{\cap} - , -$$

:

1)

$$T_{\cap}(0,0) = 0, T_{\cap}(\mu,1) = T_{\cap}(1,\mu) = \mu;$$

2)

if $\mu_A \leq \mu_C$ and $\mu_B \leq \mu_D$ then $T_{\cap}(\mu_A, \mu_B) \leq T_{\cap}(\mu_C, \mu_D)$;

3)

$$T_{\cap}(\mu_A, \mu_B) = T_{\cap}(\mu_B, \mu_A);$$

4)

$$T_{\cap}(T_{\cap}(\mu_A, \mu_B), \mu_C) = T_{\cap}(\mu_A, T_{\cap}(\mu_B, \mu_C)).$$

AND (\wedge) –

[0,1]:

$$a \wedge b : [0,1] \times [0,1] \rightarrow [0,1].$$

t-

:

$$A AND B = A \cap B = \min_x(\mu_A(x), \mu_B(x)).$$

4.3. OR (\cup) – , :

$$A OR B = A \cup B = T_{\cup}(\mu_A(x), \mu_B(x)).$$

$$T_{\cap} , T_{\cup} -$$

1)

$$T_{\cup}(1,1) = 1, T_{\cup}(\mu,0) = T_{\cup}(0,\mu) = \mu;$$

2)

if $\mu_A \leq \mu_C$ and $\mu_B \leq \mu_D$ then $T_{\cup}(\mu_A, \mu_B) \leq T_{\cup}(\mu_C, \mu_D)$;

3)

$$T_{\cup}(\mu_A, \mu_B) = T_{\cup}(\mu_B, \mu_A);$$

4)

$$T_{\cup}(T_{\cup}(\mu_A, \mu_B), \mu_C) = T_{\cup}(\mu_A, T_{\cup}(\mu_B, \mu_C)).$$

OR ()

, [0,1] :

$$a \sqcap b : [0,1] \times [0,1] \rightarrow [0,1].$$

t-

:

$$A \text{ OR } B = A \cup B = \max_x(\mu_A(x), \mu_B(x)).$$

T_{\rightarrow}

1)

$$T_{\rightarrow}(\mu, 1) = 1, T_{\rightarrow}(1, \mu) = \mu, T_{\rightarrow}(0, \mu) = 1;$$

2)

$$\text{if } \mu_A \leq \mu_B \text{ then } T_{\rightarrow}(\mu_A, \mu_C) \geq T_{\cup}(\mu_B, \mu_C);$$

3)

$$\text{if } \mu_C \leq \mu_D \text{ then } T_{\rightarrow}(\mu_A, \mu_C) \leq T_{\cup}(\mu_A, \mu_D).$$

:

$$A \rightarrow B = \max_x(1 - \mu_A(x), \mu_B(x)).$$

(□)

[0,1] :

$$a \rightarrow b : [0,1] \times [0,1] \rightarrow [0,1].$$

a, b

5.

:

$$a \rightarrow b = \bar{a} \wedge \bar{b}, a \rightarrow b = \bar{a} \vee b.$$

«if -then»

1)

2)

3)

4)

6.

$$\bar{x} = (x_1, x_2, \dots, x_n)$$

$$A' = (A'_1, A'_2, \dots, A'_n)$$

$$A'_i(x, \mu_{A'_i}(x))$$

$$\mu_{A'_i}(x) = \begin{cases} 1, & x = x_i; \\ 0, & x \neq x_i. \end{cases}$$

$$\mu_{A_{i,j}}(x), \quad j = 1..m_i.$$

$$\mu_{A_{i,j}}(x) = 1, \quad x = x_i,$$

$$A_{i,j}(x_i), \quad i = 1..n.$$

7.

$$\tilde{X} = \{\tilde{X}_i | i=1..n\} \quad \tilde{Y} = R(\tilde{X})$$

$$R = \{R_k | k=1..N\} \quad R = A \rightarrow B,$$

$$A \rightarrow B \quad B' \quad A'$$

$$B' = A' \bullet R = A' \bullet (A \rightarrow B),$$

• -

if *then* ,

(is) $\{A_{i,j} | i=1,..,n; j=1..m_i\}$ \tilde{X}

(Mamdani)

(Sugeno).

R_k : if \tilde{X}_1 is $A_{1,k}$ and ... and \tilde{X}_n is $A_{n,k}$ then \tilde{Y} is B_k ,
 $A_{i,k} \in \tilde{X}_i$ - $B_k \in B$ -

k - $(k \in 1..N)$. and

t-

R_k : if x_1 is $A_{1,k}$ and ... and x_n is $A_{1,n}$ then $y = o_k$,
 o_k - k -

1)

;

2)

$R_k, k \in 1..N$

α_k

$A'_i, i = 1..n$

$A_{i,j} (j = 1..m_i)$:

$$\alpha_k = \min_{i=1}^n \left[\max_{X_i} (A'_i \wedge A_{i,j}) \right],$$

$A'_i, i = 1..n;$ \wedge

$$\max_{X_i} (A'_i(x_i) \wedge A_{i,j}) = A_{i,j}(x_i).$$

$$\alpha_k = \min_i (A_{i,j}(x_i)).$$

$B_k.$

$$B'_k = \min(\alpha_k, B_k), \quad k = 1..N,$$

B'_k

$\alpha_k.$

$$B' = \max_k (B'_k), \quad k = 1..N.$$

8.

$$y = \frac{\sum_{j=1}^m y_j B'(y_j)}{\sum_{j=1}^m B'(y_j)} .$$

$$\mu_{o_k}(y_k) = \begin{cases} 1, & y_k = o_k \\ 0, & y_k \diamond o_k \end{cases} ,$$

$o_k -$

$k -$

$$y = \frac{\sum_{k=1}^N \alpha_k y_k}{\sum_{k=1}^N \alpha_k} .$$

9.

()

- = (,);
- = (,);
- = (, ,).

R_1 : ,
;
 R_2 : ,
;
 R_3 : ,
.

:
= {100/0.2; 200/0.4; 300/0.8; 400/1};
= {100/1; 200/0.8; 300/0.6; 400/0.4};
= {50/0.1; 71/0.8; 88/0.9; 100/1};
= {50/1; 71/0.3; 88/0.2; 100/0.1}.
:
= {0/0.1; 0.5/0.5; 1/1};
= {0/0.5; 0.5/1; 1/0.5}.

$$A'_1 = \{100/0.4; 200/0.3; 300/0.2; 400/0.1\}$$

$$A'_2 = \{50/0.1; 71/0.8; 88/0.8; 100/0.1\}.$$

∧ ∨

:

1.

$$\alpha_1 = \min[\max(0.4^{0.2}, 0.3^{0.4}, 0.2^{0.8}, 0.1^1), \max(0.1^{0.1}, 0.8^{0.8}, 0.8^{0.9}, 0.1^1)] = \min[\max(0.2, 0.3, 0.2, 0.1), \max(0.1, 0.8, 0.8, 0.1)] = \min[0.3, 0.8] = 0.3$$

$$\alpha_2 = \min[\max(0.4^1, 0.3^{0.8}, 0.2^{0.6}, 0.1^{0.4}), \max(0.1^{0.1}, 0.8^{0.8}, 0.8^{0.9}, 0.1^1)] = \min[\max(0.4, 0.3, 0.2, 0.1), \max(0.1, 0.8, 0.8, 0.1)] = \min[0.4, 0.8] = 0.4$$

$$\alpha_3 = \min[\max(0.4^{0.2}, 0.3^{0.4}, 0.2^{0.8}, 0.1^1), \max(0.1^1, 0.8^{0.3}, 0.8^{0.2}, 0.1^{0.1})] = \min[\max(0.2, 0.3, 0.2, 0.1), \max(0.1, 0.3, 0.2, 0.1)] = \min[0.3, 0.3] = 0.3$$

2.

$$B'_1 = \{0/\min(0.3, 0.1), 0.5/\min(0.3, 0.5), 1/\min(0.3, 1)\} = \{0/0.1, 0.5/0.3, 1/0.3\}$$

$$B'_2 = \{0/\min(0.4, 0.5), 0.5/\min(0.4, 1), 1/\min(0.4, 0.5)\} = \{0/0.4, 0.5/0.4, 1/0.4\}$$

$$B'_3 = \{0/\min(0.3, 0.5), 0.5/\min(0.3, 1), 1/\min(0.3, 0.5)\} = \{0/0.3, 0.5/0.3, 1/0.3\}$$

3.

$$B' = B'_1 \vee B'_2 \vee B'_3 = \{0/\max(0.1, 0.4, 0.3), 0.5/\max(0.3, 0.4, 0.3), 1/\max(0.3, 0.4, 0.3)\} = \{0/0.4, 0.5/0.4, 1/0.4\}$$

4.

$$y = \frac{0 * 0.4 + 0.5 * 0.4 + 1 * 0.4}{0.4 + 0.4 + 0.4} = \frac{0.6}{1.2} = 0.50$$

50 %.

10.

Matlab

Fuzzy logic toolbox –

Matlab

•

Matlab;

•

Matlab)

SimuLink (

;

• Matlab -
 , , . -
 :
 • (command line functions);
 • ;
 • SimuLink.
 - , -
 Matlab. -
 - , , -
 . :
 , Matlab *type* ' - . -
 . , -
 . -
 , -
 - SimuLink.
 - , -
 Matlab , -
 :
 • ;
 • ;
 • ;
 • ;
 • S- ;
 • Z- ;
 • ;
 • . -
 , -

,
 ,
 ,
 Matlab. -
 -
 ,
 ,
 -
 -
 .
 -
FIS- , , -
 -
 ; ; -
 ; ; -
 ; ; -
 FIS- -
fuzzy. , -
 (. 3.1). FIS-
Help Close,
 FIS- 8 -
- File, Edit, View , -
- And Method, Or Method, Implication,
Aggregation Defuzzification.
File - GUI- , -
 .
New FIS... -
 ,
 : **Mamdani** -
Sugeno, .
 Mamdani Ctrl+N. -
Import -
 ,
From
Workspace... From disk,
 MatLab
From Workspace... ,

MatLab.

From disk

.fis .

Ctrl+N

fuzzy FIS_name, FIS_name –

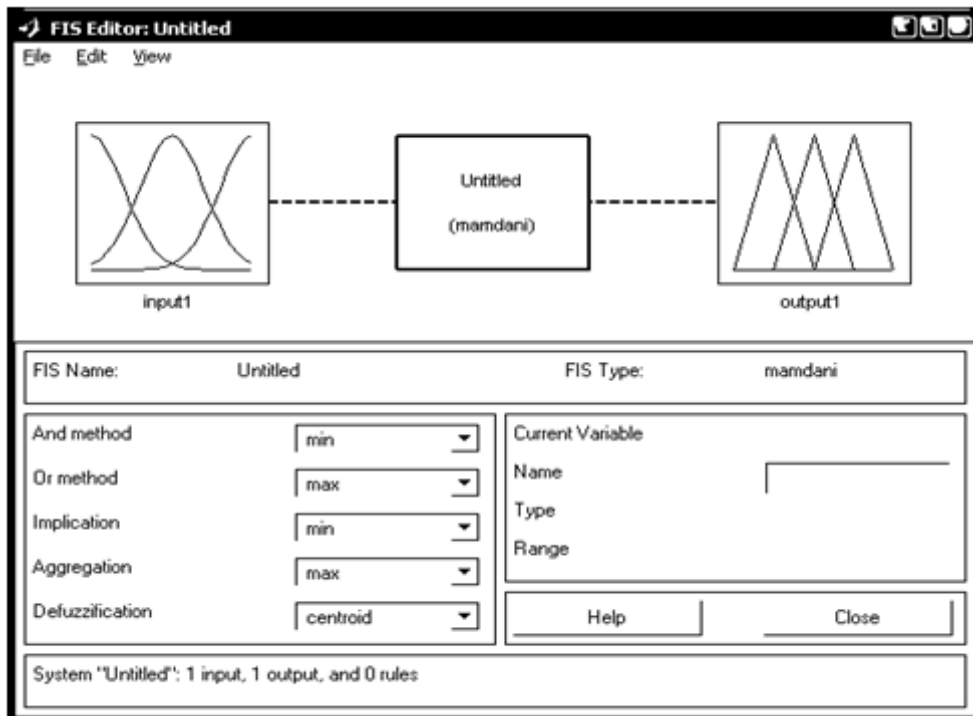

. 3.1. FIS-

Export

To

Workspace... To disk,

MatLab

To Workspace...

MatLab.

To disk

Ctrl+T Ctrl+S .

Print -

. Ctrl+P.

Close .

Ctrl+W -

Close.

Edit: **Undo** .

Ctrl+Z. **Add**

Variable... -

,

Input Output, -

. **Remove Selected Variable** -

. -

. -

Ctrl+X.

Membership Function... -

. -

Ctrl+2. -

Rules... -

Ctrl+3. -

View - GUI- , -

.

(**Rules** Ctrl+5)

« - »,

(**Surface**

Ctrl+6). -

And Method -

" ": min - ; prod - .

" " . -

Custom... , ' , , -

, .

Or Method –
 " " : max – ; probor –
 " ".
 " ".
Custom... , ' , ,
 , .
Implication –
 : min – ; prod – .
 .
Custom... , ' , ,
 , .
Aggregation –
 ,
 : max – ; sum – ; probor – " ".
 .
Custom... , ' , , ,
 , .
Defuzzification –
 .
 : centroid – ; bisector – ; lom –
 ; som – ; mom –
 .
 : wtaver – ; wtsum – .
 .
Custom...
 , , , , ,
 .
 (Membership Function
 Editor)
 : ;
 ; ,
 .

- GUI- , Membership Functions...
 Edit Ctrl+2.
 FIS-

. 3.2.

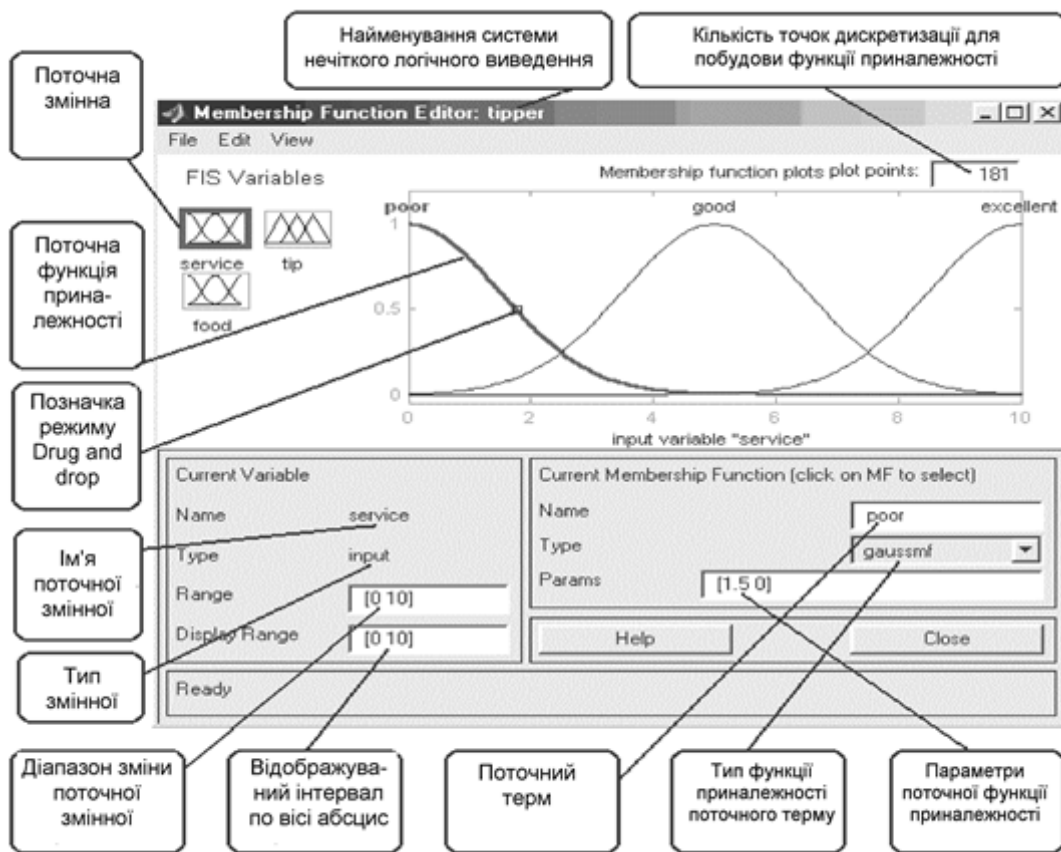

. 3.2.

File, Edit, View, Type
Range, Display Range, Name Params.

			-
	«Drug and drop».		-
		«Drug and drop»,	-
	,	,	
	.		
	.		
Edit:	Undo		.
		Ctrl+Z.	
	Add MFs...		-
,			-
.			.
	,		-
		Range.	-
	Range		
	.		
	Add Custom MF...		-
,			-
.			.
		(MF	
name),		(M-File function name)	
		(Parameter list).	
	Remove Selected MF		-
-			-
			-
			.
	Remove All MFs		-
	.		
	FIS Properties...	FIS-	-
		Ctrl+1.	
	Rules...		.
		Ctrl+3.	

Type

,
 .
 (Rule Editor) -
 - GUI- ,
 , Rules... -
Edit Ctrl+3. FIS- -
 , . -
 . 3.3. -
Help Close, -
 . -
File, Edit, View, Options, -
 , , -
 , . -
 , -
 () , -
 , -
 , -
Add Rule. -
 : , -
 - ; -
 - 1. -
 , -
 , -
 . -
 none.

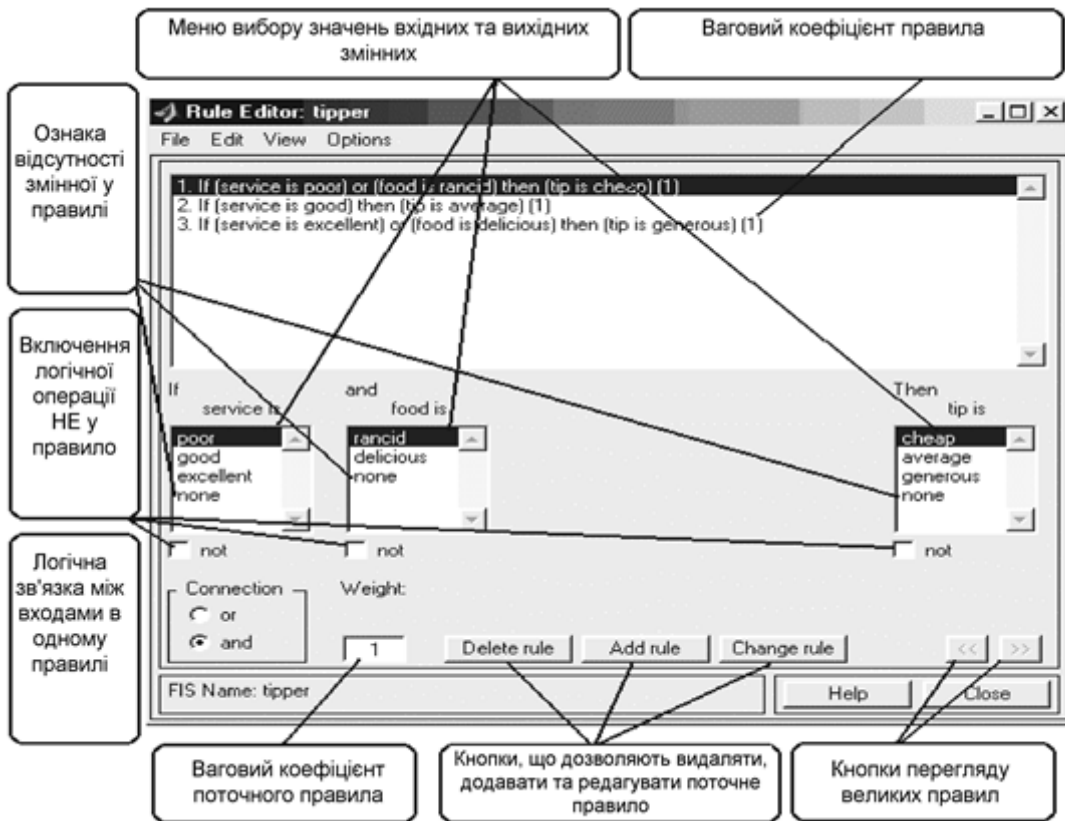

. 3.3.

Delete Rule.

Edit Rule.

MatLab

Edit:

Undo

Ctrl+Z.

FIS Properties...

FIS-

Ctrl+1.

Membership Function...

Ctrl+2.

Options

Language

English (), Deutsch (), Francais (),

Format ,
: **Verbose** – ; **Symbolic** –
; **Indexed** –

GUI- **Rule Viewer.**

. **Rule Viewer**

GUI-

,
, **View rules ... View**
Ctrl+4. **Rule Viewer**
tipper

. 3.4.

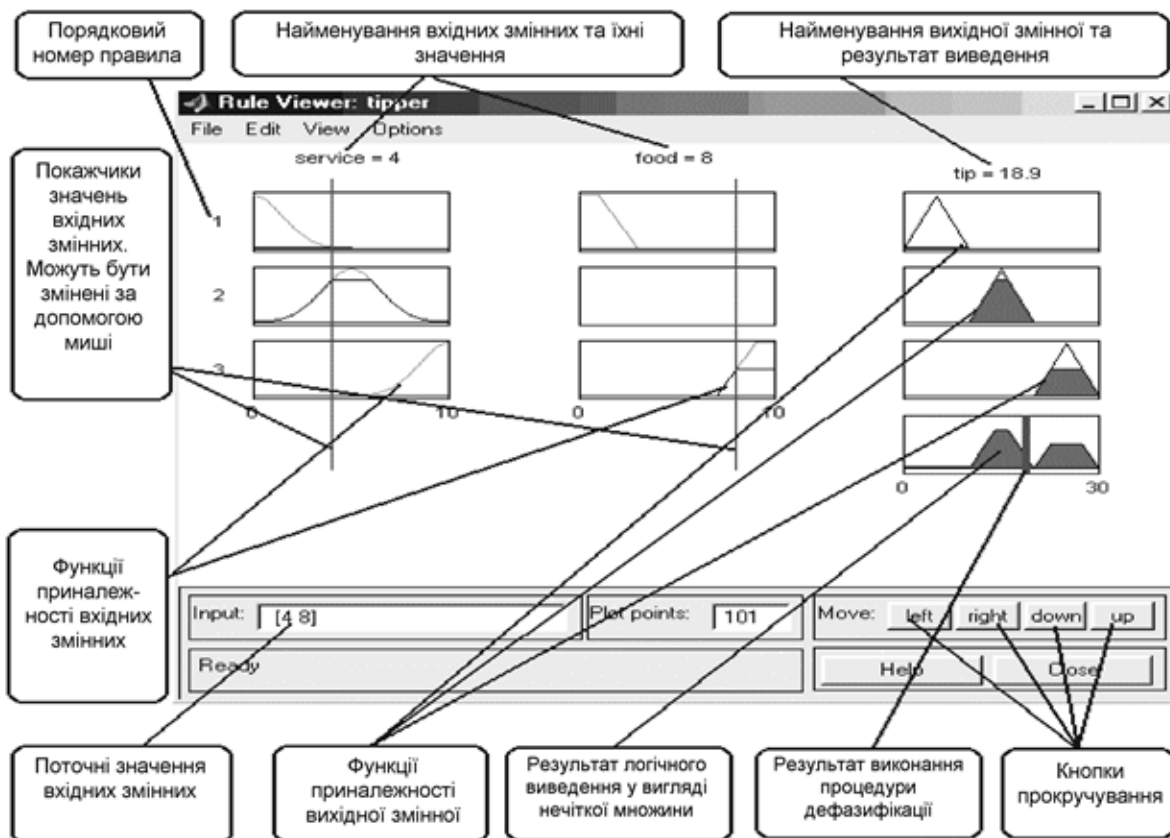

. 3.4. **Rule Viewer**

Rule Viewer

– File, Edit, View, Options,

– Input Plot points
– (left-right), (up-down).

Help Close,

.
(
)
,
none).
food (food is

Editor

Rule

Input;

Input.

Plot points

- 101.

tipper

Edit:

FIS Properties...

FIS-

Ctrl+1.

Membership Functions...

Ctrl+2.

Rules...

Ctrl+3.

Options

Format,

: Verbose –

; Symbolic –

; Indexed –

1. « »?

2.

?

3. « »?

4. « » « - »?

5. ?

6. ?

7.

?

8.

MatLab?

9.

MatLab?

10.

?

3.1

$\langle \beta, T, X, G, M \rangle,$

β — , ;

T — — , ;

X — — ;

G — — ;

$\langle X, \mu_i(X) \rangle, \mu_i(X)$ —

MATLAB

fuzzy **<Enter>**.

(),

1.

< > < > []

2. $\mu(y) = \min\{c_1, \dots, c_q\}$

3. $\mu(y) = \min\{c_1, \dots, c_q, \mu(y)\}$

3.1. $\mu(y) = \min\{c_1, \dots, c_q, \mu(y)\}$

3.2. $\mu(y) = \min\{c_1, \dots, c_q, \mu(y)\}$

3.3. $\mu(y) = \min\{c_1, \dots, c_q, \mu(y)\}$

4. $\mu(y) = \min\{c_1, \dots, c_q, \mu(y)\}$

$c_k = b_k F_k$, $b_k = \dots$

$C = (c_1, \dots, c_q)$

$\mu(y) = \min\{c_1, \dots, c_q, \mu(y)\}$

$\mu'(y) = \min\{c_i, \mu(y)\}$

- prod- : $\mu'(y) = c_i \mu(y)$;
- average- : $\mu'(y) = 0.5(c_i + \mu(y))$.

5.

$\mu_1(y), \dots, \mu_p$,

- : $\mu'(y) = \max\{\mu_1(y), \mu_2(y)\}$;
- : $\mu'(y) = \mu_1(y) + \mu_2(y) - \mu_1(y)\mu_2(y)$;
- : $\mu'(y) = \max\{\mu_1(y) + \mu_2(y) - 1, 0\}$;
- λ - : $\mu'(y) = \lambda\mu_1(y) + (1-\lambda)\mu_2(y)$, $\lambda \in [0,1]$.

- :
$$\mu'(y) = \begin{cases} \mu_1(y), & \text{if } \mu_2(y) = 0, \\ \mu_2(y), & \text{if } \mu_1(y) = 0, \\ 1, & \text{else.} \end{cases}$$

6.

$$z = \frac{\int_{y_{\min}}^{y_{\max}} y \mu'(y) dy}{\int_{y_{\min}}^{y_{\max}} \mu'(y) dy}, \quad z = \frac{\sum_{i=1}^n y_i \mu'(y_i)}{\sum_{i=1}^n \mu'(y_i)}$$

1.

$$y = (x_1^2 - 8)\cos(x_2) \quad x_1 \in [0,4]; x_2 \in [0,4].$$

```
% y=(x1^2-8)*cos(x2)
% x1 [0,4] x2 [0,4].
n=15;
x1=0:4/(n-1):4;
x2=0:4/(n-1):4;
y=zeros(n,n);
for j=1:n
y(j,:)=(x1.^2-8)*cos(x2(j));
end
surf(x1,x2,y)
xlabel('x1')
ylabel('x2')
zlabel('y')
title('Target').
```

. 3.1.1.

1.

fis-

(

fuzzy.

2.

Add Input

Edit.

3.

Input1,

1
<Enter>.

4. input2,

x2
<Enter>.

5. output1,

y
<Enter>.

6. File
Export to disk , first.

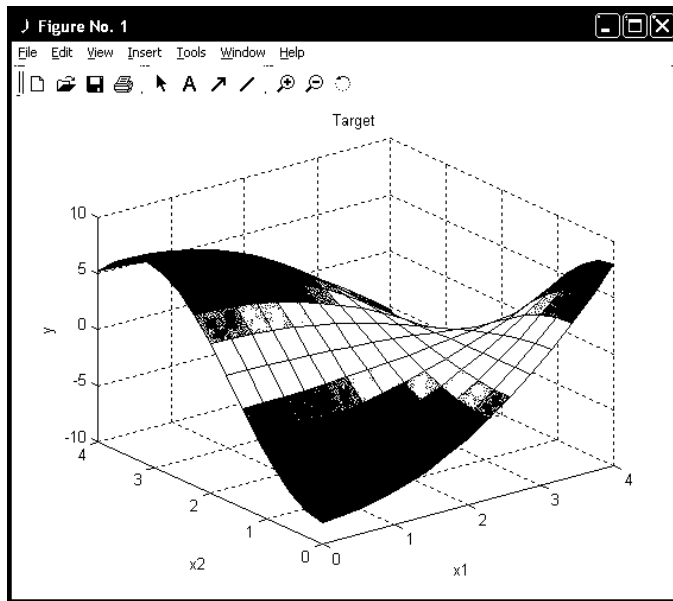

. 3.1.1.

7.

8. x1.
0 4 Range <Enter>.

9. x1.
3

Edit Add MFs...

3
 <Enter>.
 10. x1.
 (. 3.2).
 , L (), Name
 <Enter>.
 , A (), Name <Enter>.
 , H (), Name <Enter>.
 . 3.1.2.
 11. x2.
 5
 x2
 x2. 0 4
 Range (. 3.3) <Enter> Edit
 Add MFs... MF type 5
 gaussmf <Enter>.
 Number of MFs.
 12. 10
 x2: L (), LA (), A
 (), HA (), H ().
 . 3.1.3.
 13. y.
 5
 y
 y. - 10 10
 Range (. 3.4) <Enter> Edit
 Add MFs...
 5 Number of MFs.
 <Enter>.

14. $y: L (\quad), LA (\quad) A$
 $(\quad), HA (\quad), H (\quad).$

. 3.1.4.

15.

RuleEditor.

Edit

Rules

View

Edit rules....

16.

. 1.1,

:

1. $x1 = \quad x2 = \quad , y = \quad .$
2. $x1 = \quad x2 = \quad , y = \quad .$
3. $x1 = \quad x2 = \quad , y = \quad -$
- . .
4. $x1 = \quad x2 = \quad , y = \quad -$
- . .
5. $x1 = \quad x2 = \quad , y = \quad .$
6. $x1 = \quad x2 = \quad , y = \quad .$
7. $x1 = \quad x2 = \quad , y = \quad -$
- . .
8. $x1 = \quad x2 = \quad , y = \quad -$
- . .
9. $x1 = \quad x2 = \quad , y = \quad -$
- . .

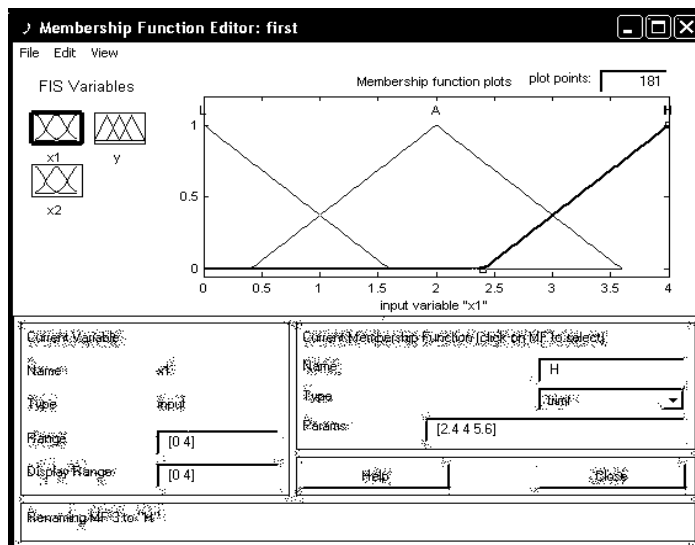

. 3.1.2.

x_1

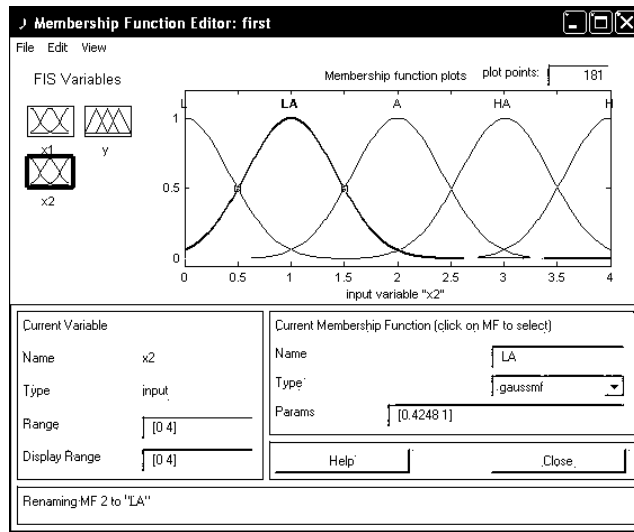

. 3.1.3.

x_2

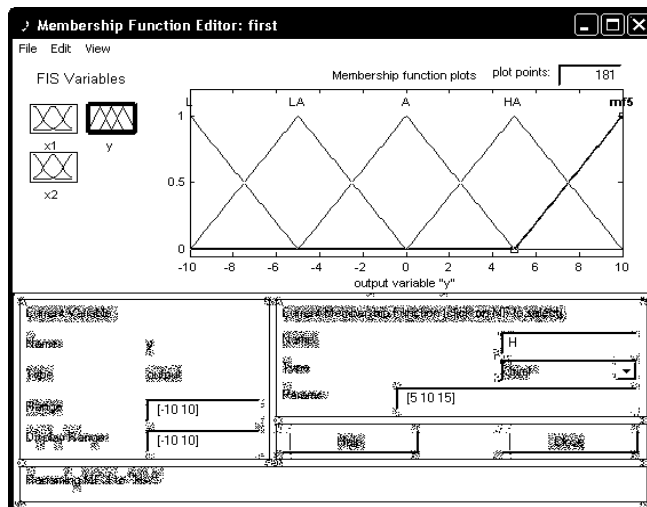

. 3.1.4.

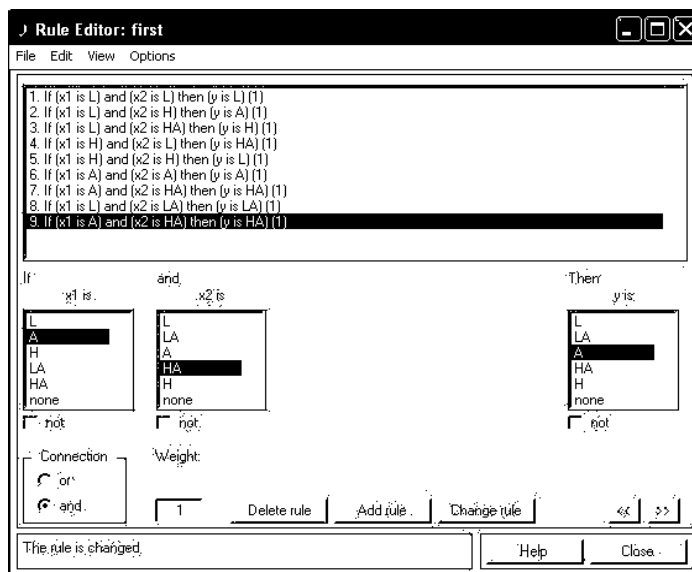

. 3.1.5.

Add rule.

. 3.1.5

9

Weight,

[0, 1].

17.

File

Export

To disk.

. 3.1.6

View rules...

View.

Input

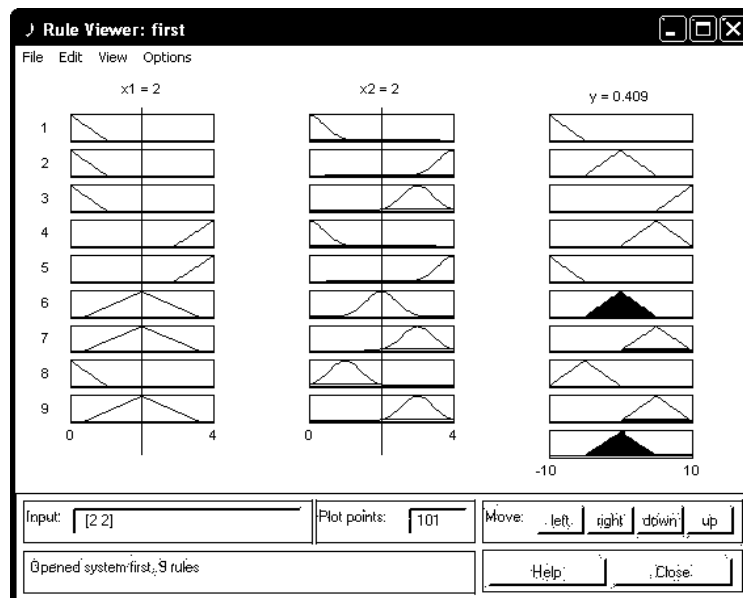

. 3.1.6.

. 3.1.7

« - »,

View surface...

View.

. 3.1.1

. 3.1.7,

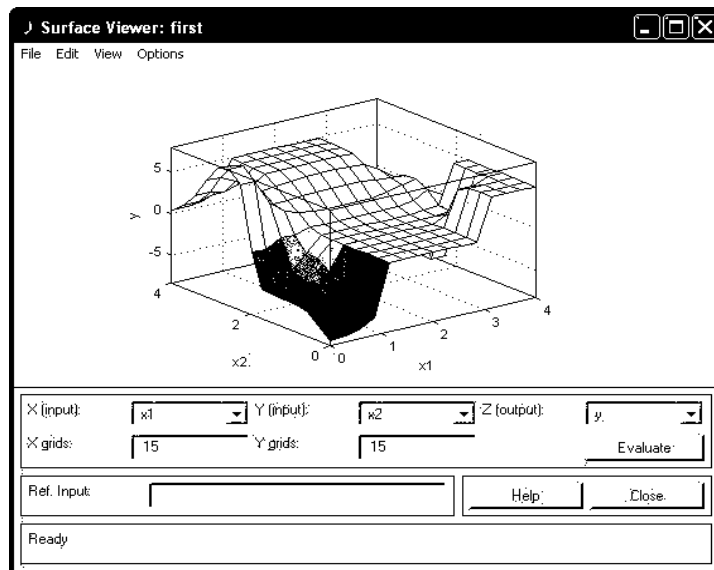

. 3.1.7.

« - »

1.

$$y = x_1^2 \sin(x_2 - 1) \quad , \quad x_1 \in [-7, 3]; x_2 \in [-4.5, 2].$$

2.

$$y = \ln(x_1 + 1) \cos(x_2) \quad , \quad x_1 \in [1, 5]; x_2 \in [0, 2].$$

3.

$$y = \ln(x_1 + 1) \frac{1}{1 + x_2} \quad , \quad x_1 \in [1, 5]; x_2 \in [0, 2].$$

3.2

.

:

(3.2.1),
 $x_1 \in [0,4]; x_2 \in [0,4]$.

$$y = (x_1^2 - 8) \cos x_2$$

<#>: « $x_1 =$ » « $x_2 =$ »
 « $y = k_1 A + k_2 B + k_0$ »

<#>: « $x_1 =$ » « $x_2 =$ »
 « $y =$ ».

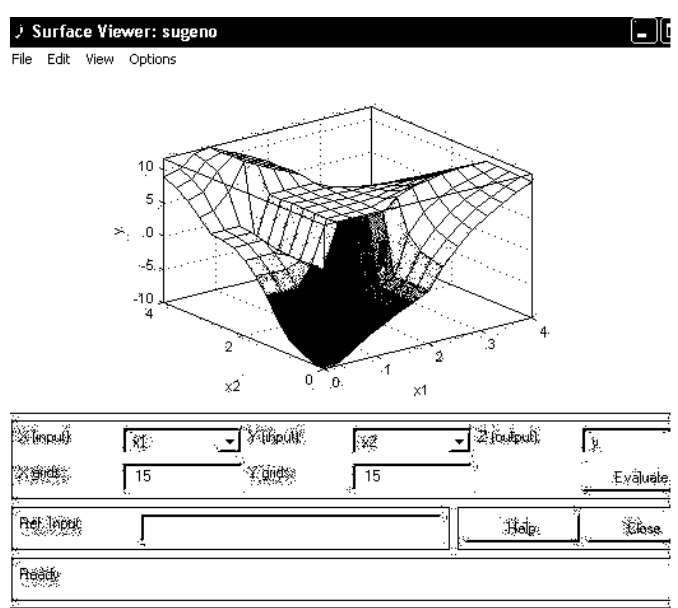

. 3.2.1.

1. $x_1 = 1, x_2 = 2, y = -10.$
2. $x_1 = 1, x_2 = 2, y = 3,75x_2 - 10.$
3. $x_1 = 1, x_2 = 2, y = 7.$
4. $x_1 = 1, x_2 = 2, y = -10.$
5. $x_1 = 2, x_2 = 2, y = 4x_1 - 10.$
6. $x_1 = 1, x_2 = 2, y = 15 - 3,75x_2.$
7. $x_1 = 2, x_2 = 2, y = 15 - 3,75x_1.$
8. $x_1 = 1, x_2 = 2, y = 7.$

9. 1 2 , $y = 7$.

10. -

1. fis- -

fuzzy Mathlab.

2. File -

New fis... Sugeno. Edit

3. Add input.

4. input1, -

x1

<Enter>. -

5. input2, -

x2

<Enter>. -

6. output1, -

y

<Enter>. -

7. File -

Export To disk , -

, FirstSugeno.

8. -

x1.

9. x1. -

0 4 Range <Enter> (. 3.2.2).

10. x_1 . -

3

x_1 . -

11.

x_2 .
 4
 x_2
 x_2 .
 x_2 .
0 4 Range **<Enter>**.
, H (**, L**, **A**, **HA**)
, H)

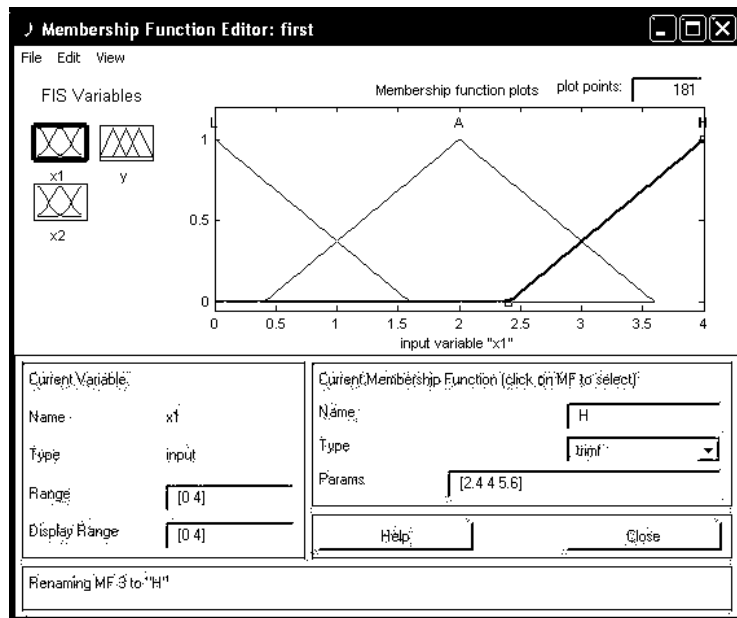

. 3.2.2. x_1

12.

(. 3.2.3).
 y , y .
 $y = -10; y = 7; y = 3,75 x_1 - 10; y = 4 x_1 - 10;$
 $y = -3,75 x_1 + 15; y = -3,75 x_2 + 15.$

Add Mfs...

Edit.

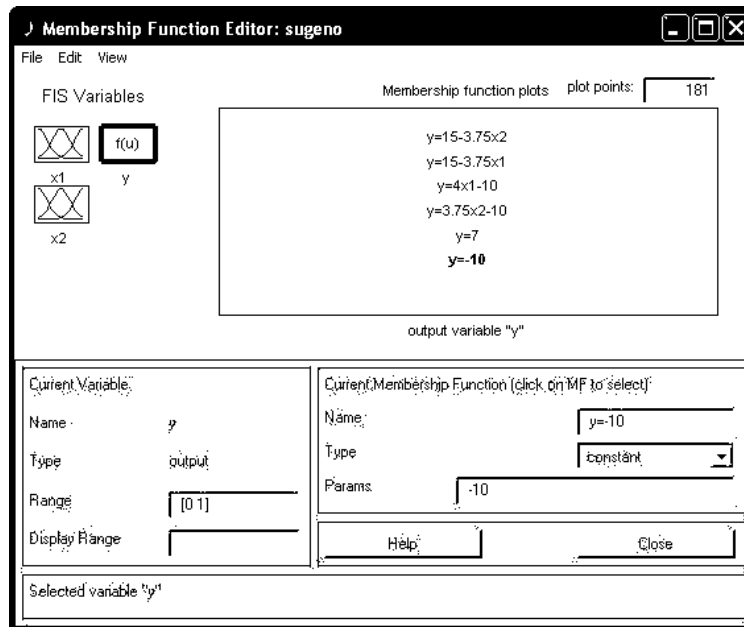

. 3.2.3.

<< - >>

13.

-

mf1.
Name,
y = -10,

,

-

constant **Type.**
- -10 **Params.**
y = 7.

-

mf3

,

,

y = 3.75 x1-10.

Linear **Type**

3.75 0 -10 **Params.**

-

:

,

- ,, -

-

6

y.

,

. 3.2.4.

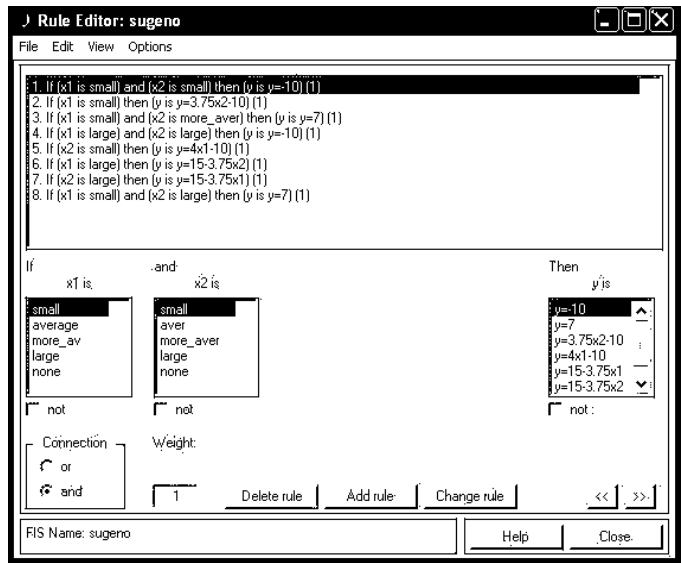

. 3.2.4.

14.

RuleEditor.

Edit

Edit rules...

Add rule.

. 3.2.3

6

. 3.2.5

View rules...

View.

Input

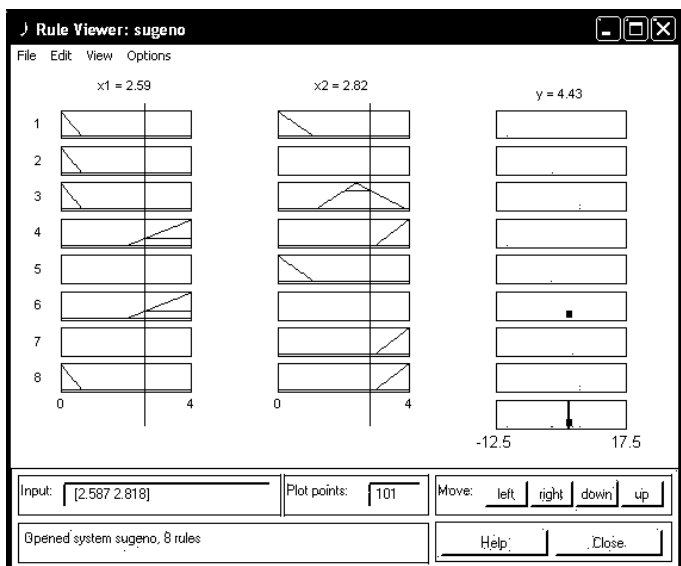

. 3.2.5.

. 3.2.6

« - »

View surface...

View.

. 3.2.1,

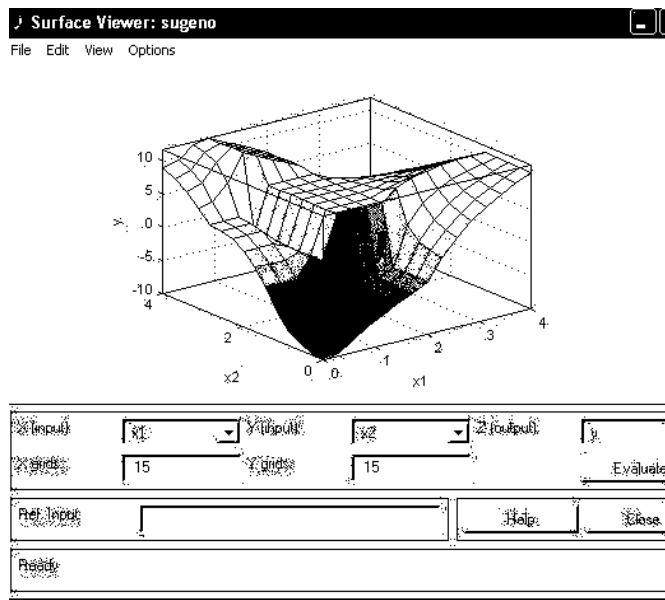

. 3.2.6.

« - »

1.

$$y = x_1^2 \sin(x_2 - 1) \quad x_1 \in [-7,3]; x_2 \in [-4.5,2].$$

2.

$$y = \ln(x_1 + 1) \cos(x_2) \quad x_1 \in [1,5]; x_2 \in [0,2].$$

3.

$$y = \ln(x_1 + 1) \frac{1}{1 + x_2} \quad x_1 \in [1,5]; x_2 \in [0,2].$$

.

-

:

.

-

,

-

,

.

-

.

1.

-

()

-

,

-

,

,

-

,

-

.

,

,

,

,

.

-

,

.

-

().

-

,

-

;

-

.

().

-

-

,

.

« »

(, NPV),

:

$$NPV = \sum_{t=0}^T \frac{P(t) - IV(t)}{(1+q)^t},$$

$P(t)$ –

$t \in [0, T]$, $IV(t)$ –

, q – ()

1.

«

»

2.

100 %.

3.

$$\frac{NPV}{NPV_{\max}}$$

4. , ,
5. . , ,
6. , , . ,
- 1,5 7. , . , 1,5
8. . , ,
9. , . ,
10. . , , . ,
11. , , . ,
12. , , . ,
13. , . ,
14. , . , 1,5
15. , . , . ,

16. , -
 , -
 . , « » -
 0 %.

17. , ,
 ,
 1,5 .

18. , ,
 ,

19. , ,
 , -
 .

0,75.

20. , , -
 , 0 %.

3.

(Risk) - « »
 $1 = \{ \langle \rangle, \langle \rangle, \langle \rangle \}$ 1 =
 $\{RD, RM, RS, RV\}$.

" (Social-meaning) -
 $2 = \{ \langle \rangle, \langle \rangle, \langle \rangle, \langle \rangle \}$ -
 $2 = \{SN, SNS, SS, SV\}$.

(NPV) - « »
 $3 = \{ \langle \rangle, \langle \rangle, \langle \rangle \}$ -
 $3 = \{ N, CS, CV \}$.

- « -
 »" (redit) -
 $T6 = \{ \langle 0 \rangle, \langle 5 \rangle, \langle 3 \rangle \}$ -
 $\langle 1,5 \rangle, \langle \rangle, \langle 1 \rangle \}$ -
 $T6 = \{P_0, P5, P3, 1_5, 1, P_1\}$.

4.

20

3.3.1.

3.3.1

1.	RD	SV	CV	P1
2.	RD	SS		P_1
3.	RM	SNS		P3
...				

1-40

« »),

min-

m -

L

FIS 3 « » (Risk), « » (Social), « » (NPV) « » (Credit).

FIS

. 3.3.2.

L

3-

L .

«

» . 3.3.3.
20

L .

20

. 3.3.4.

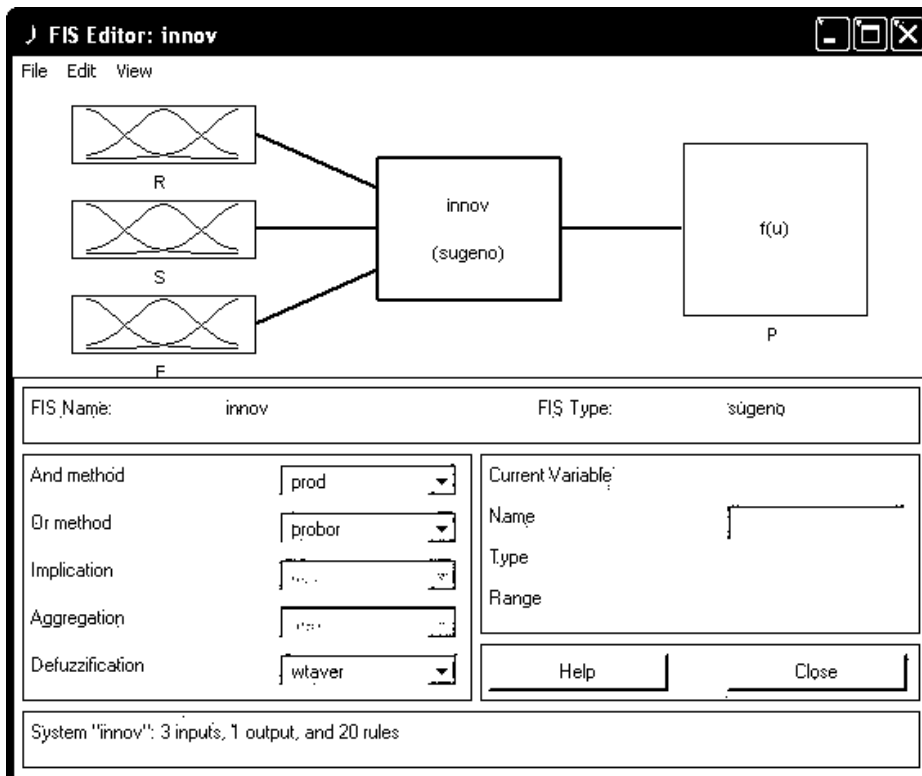

. 3.3.2.

FIS

mortgage

MATLAB

« » 0.08, 0.48 ,
« » 900.
MATLAB
« -
» 50,6 % (. 3.3.5).
-
-
»

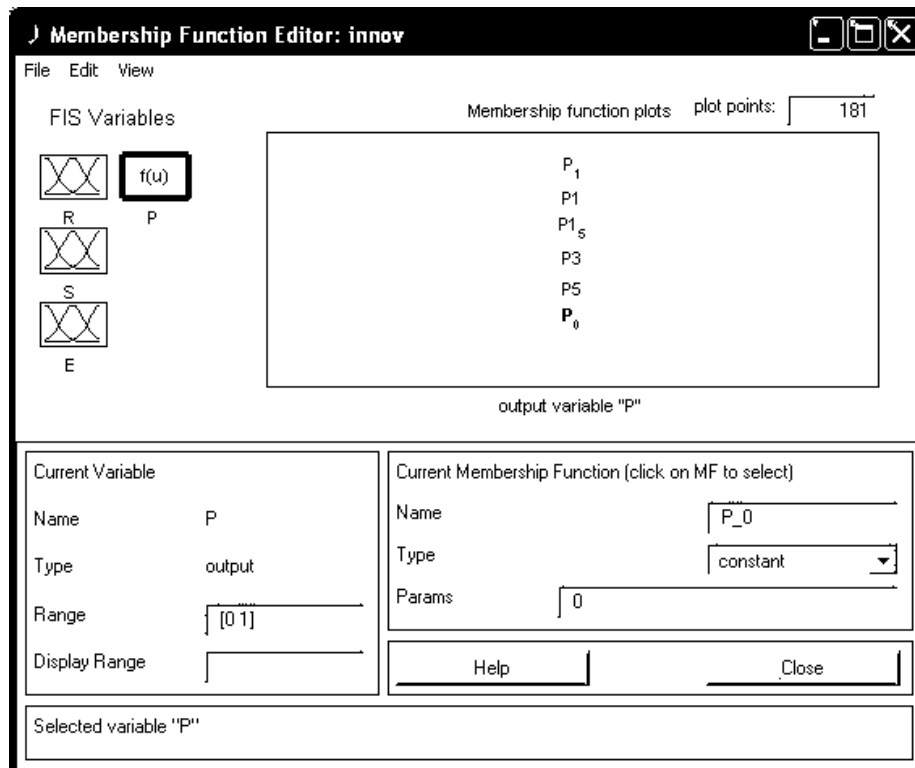

. 3.3.3.

« »

(. 3.3.6).

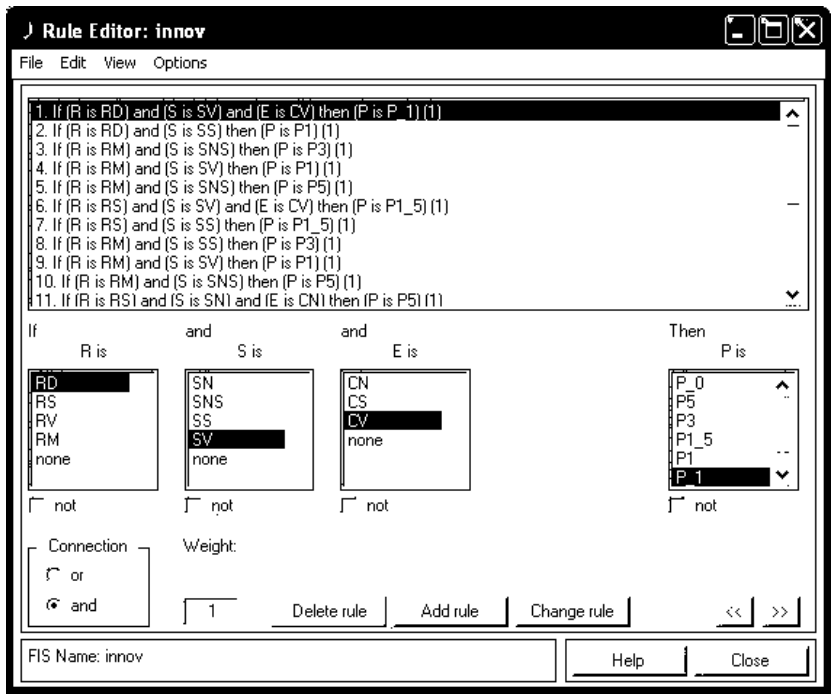

. 3.3.4.

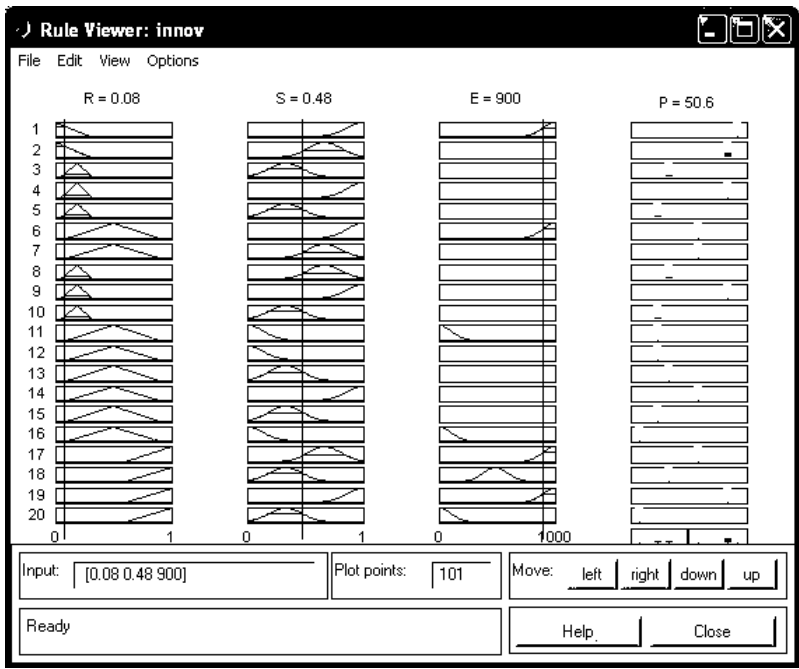

. 3.3.5.

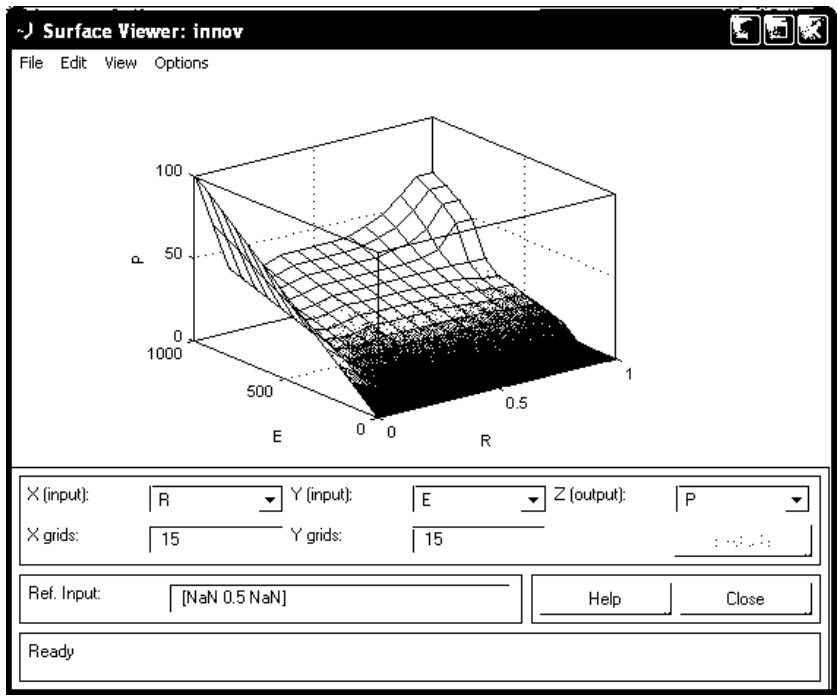

• 3.3.6.

	·	,		
			,	
	.			-
			,	-
			.	
	,	,		-
,		,		-
	.		,	-
	,		.	-
			,	-
	.			-
	,		.	-
			.	,
			.	-
			.	-
	.			-
		Fuzz Logic	lb	
L	.			
			,	
0	10.			-
0,		- 10.		

» (Location) 1 = {«
 », «
 1 = {PS, , }.

(Work-manship) 2
 = {«
 {PS, , }.

(Asset) 3 = {«
 », «
 3 = { S, , }.

(Income) T4 =
 {«
 { S, , }.

(Interest) T5 =
 {«
 , }.

» (Credit) T6 =
 {«
 T6 = {N , NS, Z, S, }.

, N.

1-40
 (« »),
 min-
 m - ,

(mortgag)
 L .

FIS 5

« (β3), « (β4), « (β5) » (β1), « (β2), « » (β6).

I, m (m), (min – (min), (centroid).

3.3.2

1	0.51	11	0.28
2	0.75	12	0.97
3	0.24	13	0.32
4	0.14	14	0.71
5	0.77	15	0.47
6	0.33	16	0.69
7	0.79	17	0.96
8	0.16	18	0.74
9	0.86	19	0.86
10	0.98	20	0.11
21	0.53	31	0.05
22	0.09	32	0.03
23	0.81	33	0.49
24	0.70	34	0.68
25	0.06	35	0.27
26	0.58	36	0.40
27	0.78	37	0.59
28	0.91	38	0.14

29	0.17	39	0.75
30	0.34	40	0.59

3.4

•

∴

•

— , , -

, - , -

) (.

,

•

-

∴

1) , -

2) ;

, ,

∴

3) ;

, .

,

-

-

,

,

,

,

, « »

?»,

?».

[0,1].

() .

()

$$A = \{a_1, a_2, \dots, a_n\},$$

$$P = \{p_1, p_2, \dots, p_q\},$$

A.

$$a_i \in A$$

$$x_i = \{x_i^1, x_i^2, \dots, x_i^q\},$$

$$x_i^j \in R -$$

$$p_j \in P$$

$$a_i \in A.$$

-(,)

(, , , ...);
 ;
 - , :
 ;
 , ;
 ;
 ; -
 ;
 - : ;
 , ;
 , ;
 ;
 ;
 - : ;
 , ;
 , ;
 ;
 , ;
 , / .
 , $x_i^j \in R$

$$x_i = \{x_i^1, x_i^2, \dots, x_i^q\}$$

D (n*q),
 x_i .

$$R(A) = \{A_k \mid A_k \subseteq A\}$$

$$J(A) = \{A_k \mid A_k \subseteq A\}$$

$$A_k (k \in \{2, \dots, c\}),$$

$$F(R(A))$$

$$F(J(A))$$

fcM MATLAB,

$$F(J(A))$$

$$A_k (k \in \{2, \dots, c\}),$$

$$\sum_{k=1}^c \mu_{A_k}(a_i) = 1, (\forall a_i \in A), \quad (3.1)$$

$$A_k (k \in \{2, \dots, c\}),$$

$$v_k \quad A_k (k \in \{2, \dots, c\}),$$

$$v_j^k = \frac{\sum_{i=1}^n (\mu_{A_k}(a_i))^m x_i^j}{\sum_{i=1}^n (\mu_{A_k}(a_i))^m}, (\forall k \in \{2, \dots, c\}, \forall p_j \in P), \quad (3.2)$$

m -

(m > 1).

$$v_k = (v_k^1, v_k^2, \dots, v_k^q)$$

R^q ,

$$F(A_k, v_k^j) = \sum_{i=1}^n \sum_{k=1}^c (\mu_{A_k}(a_i))^m \sum_{j=1}^q (x_i^j - v_k^j)^2. \quad (3.3)$$

$$m > 1.$$

$$c \in N, c > 1,$$

$$m,$$

$$U$$

,

$$a_i \in A$$

$$A_k (k \in \{2, \dots, c\}),$$

(4.3)

(4.1)–(4.2),

:

$$\sum_{i=1}^n \mu_{A_k}(a_i) > 0, (\forall k = \{2, \dots, c\})$$

$$\mu_{A_k}(a_i) \geq 0 (\forall k = \{2, \dots, c\}, a_i \in A)$$

(3.4)

(4.4)

(4.3) –

fuzzyISODATA. 1980

FCM, Fuzzy-C-Means.

MATLAB.

FCM

$$R(A) = \{A_k \mid A_k \subseteq A\},$$

FCM

FCM

1. :

$$s \in N,$$

$$\varepsilon \in R_+,$$

$m > 1.$

D

$$R(A) = \{A_k \mid A_k \subseteq A\}$$

$$\mu_k(a_i), \forall k \in \{2, \dots, c\}, \forall a_i \in A.$$

2.

$$R(A) = \{A_k \mid A_k \subseteq A\}$$

(6.2)

$$v_k^j, (\forall k = \{2, \dots, c\}, \forall p_j \in P)$$

(6.3).

1.

3.

$$R'(A) = \{A_k \mid A_k \subseteq A\}$$

$$\mu_k^1(a_i), \forall k \in \{2, \dots, c\}, \forall a_i \in A,$$

:

$$\mu_k^1(a_i) = \left(\frac{\left(\sum_{j=1}^q (x_i^j - v_k^j)^2 \right)^{\frac{1}{2}}}{\left(\sum_{j=1}^q (x_i^j - v_l^j)^2 \right)^{\frac{1}{2}}} \right)^{\frac{2}{m-1}}, \forall k \in \{2, \dots, c\}, \forall a_i \in A$$

4. $\mu_k^1(a_i) = 1, \quad k \in \{2, \dots, c\} \quad a_i \in A$

$$\sum_{j=1}^q (x_i^j - v_k^j)^2 = 0,$$

$A_k \quad \mu_k^1(a_i) = 1,$

$A_l (\forall l = \{2, \dots, c\}, l \neq k) \quad \mu_l^1(a_i) = 0.$

$k \in \{2, \dots, c\} \quad a_i \in A,$

$\mu_k^1(a_i) = 1, \quad \mu_l^1(a_i) = 0.$

5. $R'(A) = \{A_k \mid A_k \subseteq A\}$

(6.2)

(4.3).

6. $\varepsilon \in R_+, \quad s$

$R'(A) = \{A_k \mid A_k \subseteq A\}$

$R(A) = R'(A) \quad 3,$

1

$R^*(A),$

$\mu_k(a_i),$

$v_k = (v_k^1, v_k^2, \dots, v_k^q).$

FCM

MATLAB

fcn

:

$[center, U, obj_fcn] = fcm(data, cluster_n)$

$[center, U, obj_fcn] = fcm(data, cluster_n, options)$

– data: D , $a_i \in A$

$$x_i = \{x_i^1, x_i^2, \dots, x_i^q\};$$

– cluster_n: $c \in N, c > 1$.

– center: v_k

$$v_k = (v_k^1, v_k^2, \dots, v_k^q);$$

– U: $\mu_k(a_i), \forall k \in \{2, \dots, c\}, \forall a_i \in A;$

– obj_fun: (3)

options, fcm()

– option (1): m
 $U(m = 2);$

– option (2): $s(100);$

– option (3): $\epsilon(0.00001);$

– option (4): $(, 1).$

NaN (),

1.

MATLAB.

fcmdata.dat,

D

140

2

1.

Load fcmdata.dat

plot(fcmdata(:,1), fcmdata(:,2), 'o')

. 3.4.1.

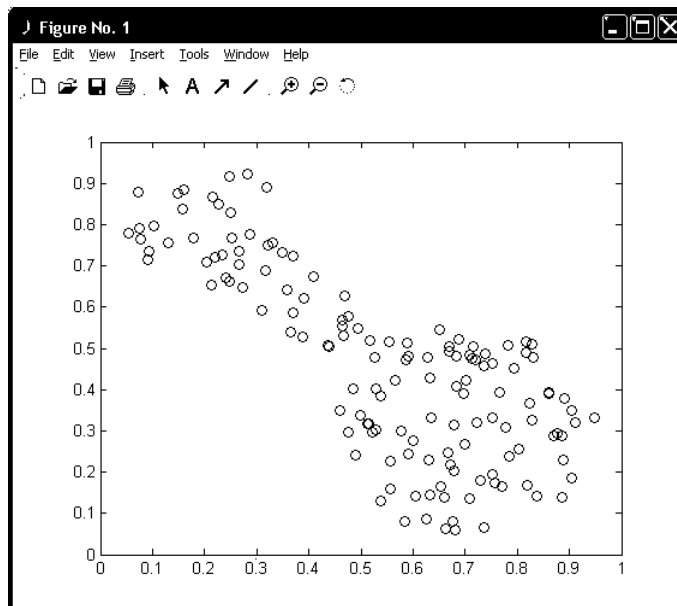

. 3.4.1.

D

fcmdata.dat

2.

fcmdata,

:

[center, U, obj_fcn]=fcm(fcmdata, 2).

—

—

—

:

,

center;

— U;

— obj_fcn.

```

load fcndata.dat
plot(fcndata(:,1), fcndata(:,2),'o')
[center, U, obj_fcn]= fcm(fcndata, 2);
maxU=max(U);
index1 = find(U(1,:)== maxU);
index2 = find(U(2,:)== maxU);
line(fcndata(index1,1), fcndata(index1,2),'linestyle','none',...
'marker', 'x', 'color', 'g');
line(fcndata(index2,1), fcndata(index2,2),'linestyle','none',...
'marker', 'x', 'color', 'r');
hold on
plot( center(1,1), center(1,2),'ko', 'markersize',10, 'LineWidth', 2)
plot( center(2,1), center(2,2),'ko', 'markersize',10, 'LineWidth', 2)

```

. 3.4.2.

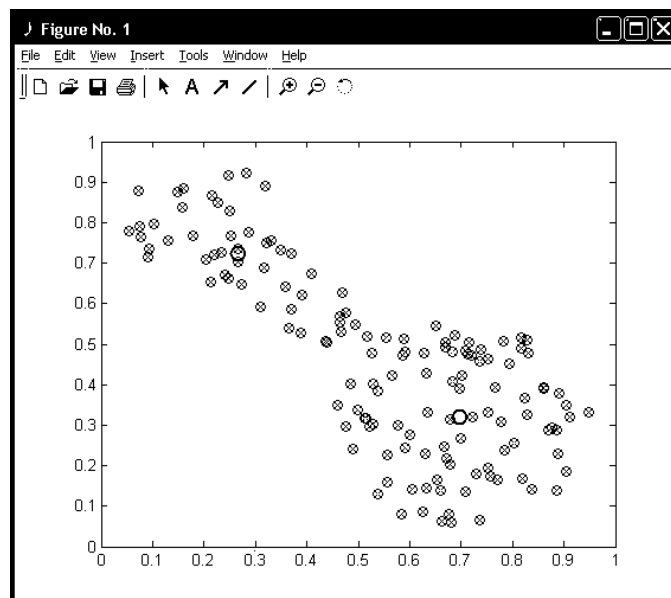

. 3.4.2.

3.

MATLAB

center U,

Enter.

4. ,
:
[center, U, obj_fcn] = fcm(fcndata, 2, [2.5 1000 0.000001 1]);
2.5,
1000, $\epsilon = 0.000001$.

fcm,

5. ,
MATLAB

findcluster.

(subtractive clustering,
subclust).

6.

: **findcluster**

findcluster('file.dat').

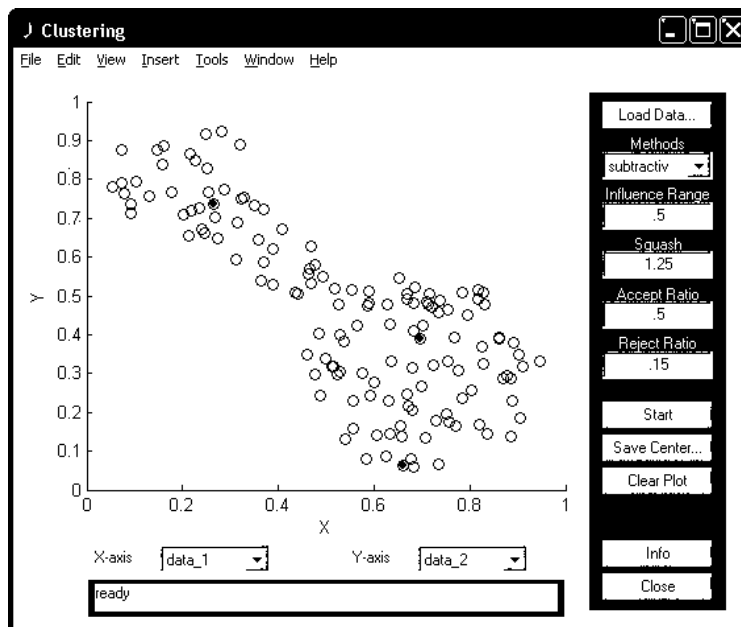

. 3.4.3.

Methods,
Start.

6.

1)

2)

radii,

radii

[C, S] = subclust (X, radii, xBounds, options)

radii

[0,1]

radii

radii 0.2 0.5.

xBounds

(2xq),

q -

```

options,
:
- options(1) = guashFactor -
radii
( 1.25);
- options(2) = acceptRatio -
0.5);
- option(3) = rejectRation -
0.15);
- options(4) = verbose -
0,
( 0).
subclust

```

σ - , S

σ - .

:

Load fcmdata.dat

```

[C, S] = subclust(fcmdata, [0.5 0.5], [], [1.25 0.5 0.15 1])
- 0.5 0.5.

```

. 4.3,

suclust

findcluster.

MATLAB

1. $(1,2); (2,1); (1, 2); (3,2); (2,3); (1,6); (2,5); (3,6); (5,5); (5,6); (7,5); (7,6).$

3

. 3.4.4.

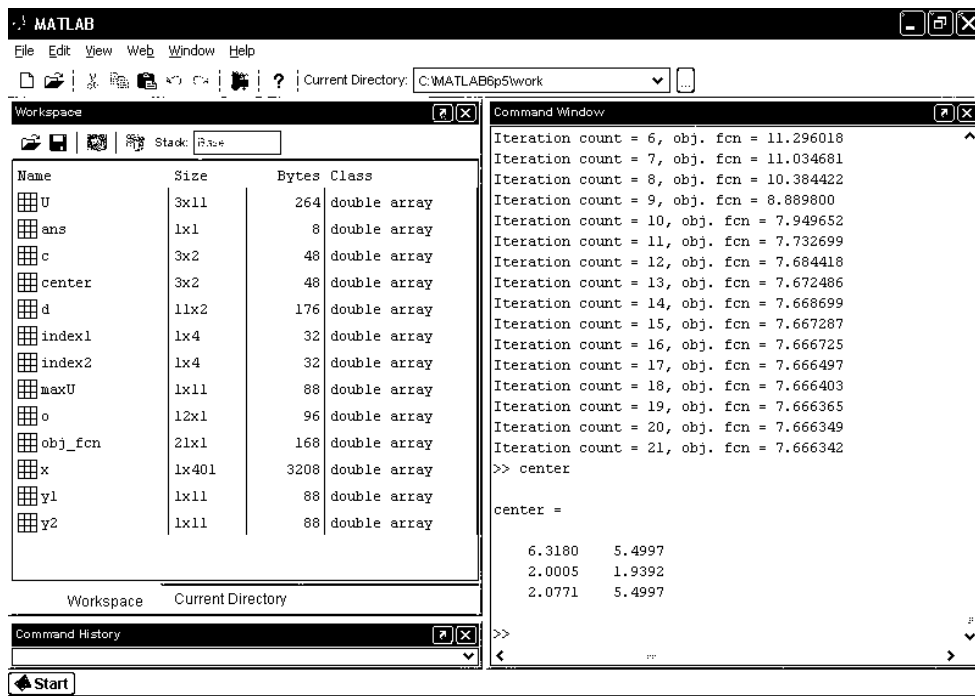

. 3.4.4.

1

2.

10

(2, 3 4).

1		100	120	300	250	200
		0,1	0,3	0,2	0,2	0,2
2		120	400	200	150	300
		0,2	0,4	0,1	0,2	0,1
3		200	250	260	150	300
		0,3	0,3	0,2	0,1	0,1
4		120	100	200	150	130
		0,2	0,4	0,2	0,2	0,2
5		520	400	250	450	300
		0,6	0,1	0,1	0,1	0,1
6		520	400	200	450	300
		0,2	0,4	0,1	0,2	0,1
7		220	300	200	150	300
		0,2	0,3	0,2	0,2	0,1
8		100	300	200	150	300
		0,2	0,2	0,3	0,1	0,2
9		230	400	200	250	200
		0,1	0,3	0,2	0,2	0,2
10		220	120	200	350	400
		0,1	0,5	0,1	0,2	0,1

?

4

1. () .
2. , .
3. .
4. .
5. .
6. .

1. ()

—
·
« » , « —
—
—
» .
—
·
— (—) ,
— · , —
—
·
·

2. , (—) —

—
·
—
·
— , —
·

system) – (knowledge-based

, , -
, -
,
, , ,
.

3.

– ;
– ;
– ;
– , -
– ;
– ;
– , -
– , ,
(), (-
, (-
, (),
, , -
– .
– , -
– ,
– , .
, .
, .
,

4.

(7.7):

- ;
- ;
- .

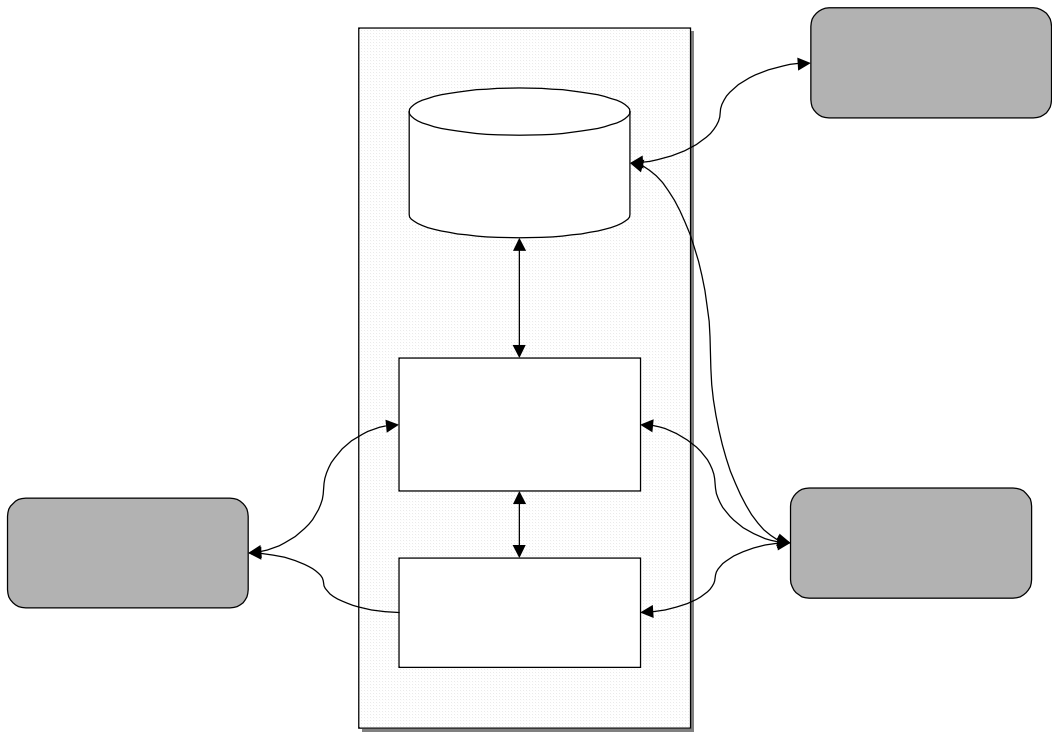

. 4.1.

) - , , (- , , - , , - , .

- 1)
- 2)

(

—
, · , — ()
, —
, ·

5.

:
— — ;
, — ;
(, , —);
— ,
, — ,
; ,
; —
, — , ·

6.

, , —
· , —
· —
, , —
, · —
, , —
, · —
· —
· , —
· —
, , —
· —
· —

, ,
 . , ,
 - ,
 , ,
 . ,
 , ,
 , .
 , ,
 , .
 , ,
 , .
 , ,
 . ,
 , ,
 , ,
 , .
 , ,
 . ,
 , ,
 , .
 , ,
 . ,
 , ,
 , .
 , ,
 , .

— (, S-5,); , -

— , ; , -

— , . : -

— ; ; -

— . , , -

— , . , -

— . , -

— . , -

— , . , -

— , . , -

— , . , -

— , Web- . Web-

— , . Web-

1. ?

2. .

3. , .

4. ?

5. ?

6. ?

7. .

WEB

1. Web.
2. .
3. .
4. -
5. .
6. .
7. .
8. .

1.

Web

« » -

,

,

,

—

,

.

,

.

— , -

,

,

,

,

,

.

,

,

,

.

,

,

.

,

,

[4].
(« » — « », « » — « », « »)
») — ,
— .
, , , , , , ,
. ,
Physical Agents): — FIPA (Foundation for Intelligent
,
. ,
: ,
. :
— ,
, , , ,
.

, , , . , , - , - , . , - , . , - , , . , - , , () - , , , .

2.

: - $O = \langle X, \mathfrak{R}, \Phi \rangle$, - $\mathfrak{R} - O;$ () , - $\Phi -$; / O.

$$\Phi = \emptyset \quad \mathfrak{R} = \emptyset,$$

$$: \quad \mathbf{O} = \mathbf{V} = \langle \mathbf{X}, \{ \}, \{ \} \rangle.$$

), (,) . -

$$\mathfrak{R} = \emptyset, \quad \Phi \neq \emptyset,$$

f Φ .

$$\mathbf{O} = \mathbf{T}^0 = \langle \mathbf{X}, \{ " \} , \{ " \} \rangle .$$

— ; — , ; — .

3.

. 5.1.

— , , . , .

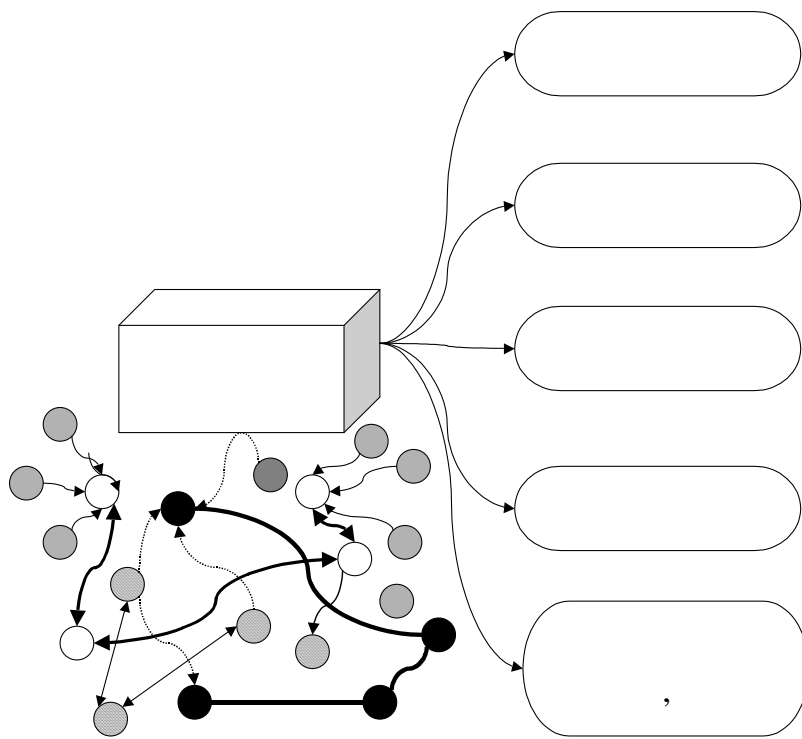

. 5.1.

–
 – ; ,
 . , ;
 , ;
 .
 , IDEF5 (INTEGRATED
 DEFinition), :
 1) –
 ;
 2) ;
 3) –
 ;
 4) ;
 5) –
 . :
 TOVE (Toronto Virtual Enterprise), Ontolingua, KACTUS (ESPIRIT), SHOE (Simple HTML Ontology Extensions), Plinus, yc (MCC), ()², Semantic Web (W3C) .
 Web
 Semantic Web –
 OWL (OWL Web Ontology Language),
 DAML+OIL Web Ontology Language RDF
 (Resource Description Framework). OWL –
 , OWL
 : (headers), (class
 elements), (property elements)
 (instances), –
 ,
 . ,
 – ,

()² -

()²

- (ontological engineering);
- Web- ;
- Web-

Web-

SHOE

Web-

SHOE

(reusable ontologies)

Web-

(Knowledge Annotator).

4.

(- DL)

DL

Semantic Web

. DL -

DL

DL -

NC;

NI;

NR.

, DL
 . DL
 , DL,
 ()
 DL
 XML
 -XML-
 XML-
 Semantic Web,
 XML
 Semantic Web. 1
 XML-
 RDF(S)
 XML-
 « , ».
 -

OWL , RDF(S) , -
 . , OWL -

OWL Semantic Web.

5.

, , -
 , , -
 , - , , -
 , - , , -
 . (, - , , -
). - , , . -
 . -
 RDF OWL. , CMS, -
 , SPARQL RDF, RDF, -
 , Semantic Web -
 , (, , -
), , -
 : , -
 - , -
 - ; -
 , -
 , , -
 , ,

(, , -
 ,) ;
 - ,
 - ;
 - (-
 , , -
) - , -
 - ;
 - , -
 , -
 ; -

SPARQL.

Semantic Web

OWL;

Ontolingua.

– *Protégé, Chimaera*
Protege.

Protégé –

Protégé-Frames

Protégé-OWL.

Protégé,
Protégé.

Protégé

(XML)

(OWL-RDF).

Protégé, ,
RDF OWL. -
Protégé , . Protege -
, -
, -
, -
Protégé Frames -
Protégé. -
OKBC (Open Knowledge -
Base Connectivity). -
, ,
OWL, W3C. -
<X,RF) , ,
, ,
Protégé. ,
Protege , -
, -
OWL, , , -
, -
, ,
Protégé -
, , Protégé -
, -
, , -
HermiT, Snorocket, , , -
.

2)

: Cyc method, Methology
by Uschold King, METHONTOLOGY, On-To-Knowledge

(Sensus, Kaktus, Uschold and King, Gruninger and Fox, Noy
and McGuinness),

(Methontology, OTK, UPON).

HCOME DILIGENT),

IDEF5

SADT

(Structured Analysis and Design Technique)

IDEF_x

), - , - IDEF5 (-
 . SADT ,)
 (« - ' »).
 , :
 1) . ,
 ;
 2) . ;
 ;
 3) . -
 ;
 4) . -
 ;
 5) .
 .
 IDEF5, ,

METHONTOLOGY

METHONTOLOGY

« »

METHONTOLOGY

1.

2.

3.

4.

5.

6.

7.

8.

9.

(TextToOnto, Text2Onto, OntoLT, OntoLearn).

(,)

),
:
Text2Onto, OntoLT, OntoLearn (TextToOnto,).

:
(PROMPT, AnchorPROMPT, GLUE, FCAMerge).

;
;
;
;
« ».
,
,
(, Web-
API,).

8.

- 1) :
- 2) ;
- 3) ;
- 4) ;
- 5) ;
- 6) ;

OWL 2.0.

- 1. Web.
- 2. -
- 3. ?

4.

?

5.

?

6.

?

7.

?

8.

.

6

SEMANTIC WEB

1. Semantic Web.
2. Semantic Web.
3. Resource Description Framework (RDF) Web Ontology Language (OWL) – , Semantic Web.

1. Semantic Web

Semantic Web

. , -
, -
. , -
, -
, -
. Semantic Web -
; , -
, -
. Semantic Web -
:
- ;
- ;
- ;
- Web ,
;
- ;
- (discovery) Web- ;
- ;
- -

2. Semantic Web

Semantic Web

. Semantic Web

:

- RDF;
- OWL;
- SPARQL – RDF;
- SWRL.

Semantic Web

«data-centric»

Semantic Web –

Semantic Web

Semantic Web –

Semantic Web

Web

Semantic

Web

().

Semantic

(URI), Sema-

Web, –
tic Web,

Semantic Web

:
 Semantic Web,
 Semantic Web, (
), Semantic Web,
 Semantic Web.
 Semantic
 Web,
 Semantic Web
 Semantic Web Web- :
 WWW.
 WWW
 Semantic Web
 WWW
 Semantic Web
 ,
 ,
 .

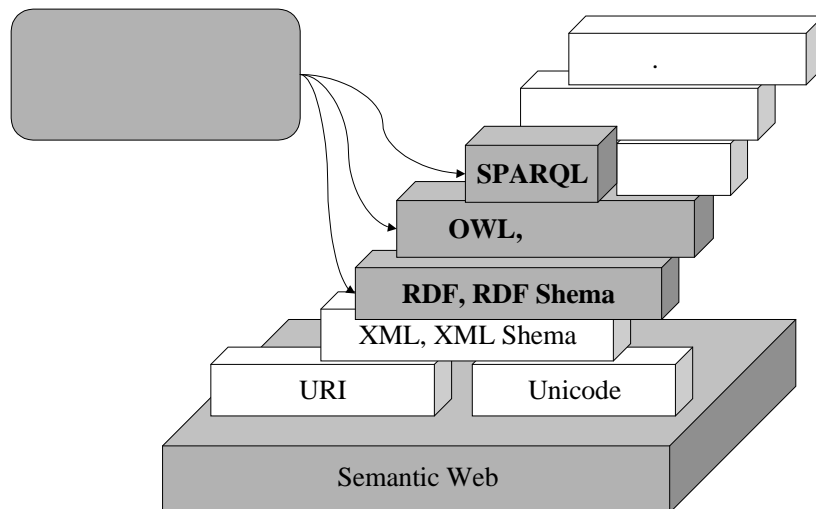

. 6.1. Semantic Web

Semantic Web

Semantic Web

Web-

Semantic Web –

Web-

(knowledge representation, KR),

(artificial intelligence, AI),

3. Resource Description

Framework (RDF) Web Ontology Language (OWL) –

Semantic Web

Resource Description Framework (RDF)

Web Ontology Language (OWL) –

Semantic Web,

Web-

RDF

BI 2.0

Semantic Web (. 3):

Resource Description Framework (RDF);

Web Ontology Language (OWL);

SPARQL (SQL like query language for RDF).

RDF

RDF (Resource Description Framework) –

1999

W3C

					-
					-
		RDF –		« ’	-
		»			-
				, RDF	-
					-
		XML Schema			-
		, RDF Schema			-
			RDF (, authorOf)	-
					-
			RDF Schema		-
		RDF.			-
			Class, subPropertyOf	subClassOf,	-
				RDF	-
			RDF (XML –	-
XML).					-
		2.0 RDF			-
					-
					-
			Oracle		-
			100		-
				Semantic Web,	-
		Oracle	Oracle Database	10g Enterprise	-
Edition.			Java-		-
			Oracle 10g	RDF.	-
			Oracle	2005	-
		RDF	Spatial 10.2g		-
RDF.				RDF	-
					-
			Web.	Microsoft	-
Services Framework 3.0 Developer Guide			2006		-
			RDF		-
1) RDF					-

; 2)

Web-

OWL

OWL (Web Ontology Language)

OWL Web,
URI. OWL
XML, RDF, RDF Schema DAML+OIL.

XML- DTD (Document Type Definition)

XML-
2.0 OWL

SPARQL

RDF, RDF, SQL
SPARQL RDF Query Language
SPARQL

RDF

SPARQL,

Web-

« »

(SPARQL)

SPARQL – , RDF.
 SPARQL
 RDF -
 SPARQL,
 Web- ,
 (,
 SPARQL)
 SPARQL ,
 Web 2.0:
 Web 2.0. SPARQL
 , RDF -
 RDF -
 (middleware). SPARQL 2.0

1. Semantic Web?
2. Semantic Web?
3. Resource Description Framework (RDF) Web Ontology Language (OWL) – , -
 Semantic Web?
4. RDF?
5. OWL?
6. SPARQL – RDF?
7. SWRL?

DATA MINING

- 1.
- 2.
- 3.
- 4.
- 5.
- 6.

1.

() -

,

.

Data Mining.

,

,

,

().

,

.

2.

,

:

,

.

, : -
 f, -
 (.7.1), -
 .

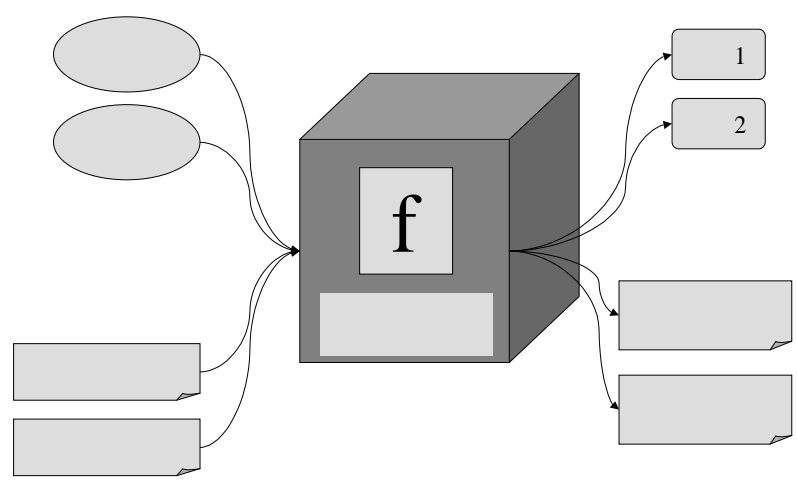

.7.1.

FIPA (Federation of Intelligent Physical
 Agents), - , -
 , , -
 , . -
 , -
 . FIPA - , 1996 -
 . -
 , , -
 , : -
 - (reactivity) -
 ; -
 - (autonomy) -
 ; -
 - collaborative behavior) -
 ;

– («knowledge level»
 communication ability) –
 , ;
 – (inferential capability) –
 , -
 ,
 ;
 – (temporal continuity) – -
 ;
 – (personality) –
 ;
 – (adaptivity) –
 ;
 – (mobility) –
 .
 – – , -
 ;
 – – , -
 ;
 – – ,
 .
 – , -
 . (), -
 (–)
 (.7.2). :
 (autonomy) – -
 ;
 (social ability) – -
 -
 -
 ;

(reactivity) –
;
(pro-activity) –

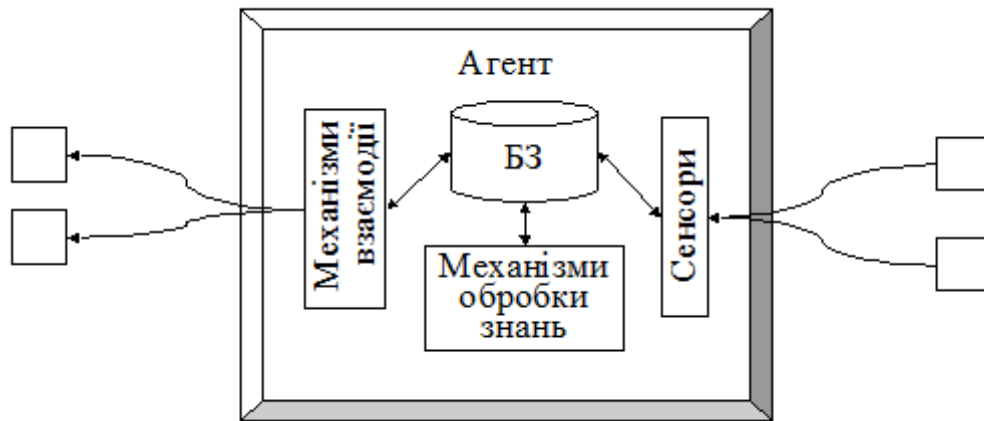

. 7.2.

Data Mining,

(), , (), -
 ,
 .
 , (,), -
 (,) (-
) , (-
 : , . -
 , -
 . -
 , -
 (,) -
 .
 , .
 : -
 , -
 .
 , -
 .

3.

, (

) ().

, . , -
(, , -
, -
) . (.7.3).

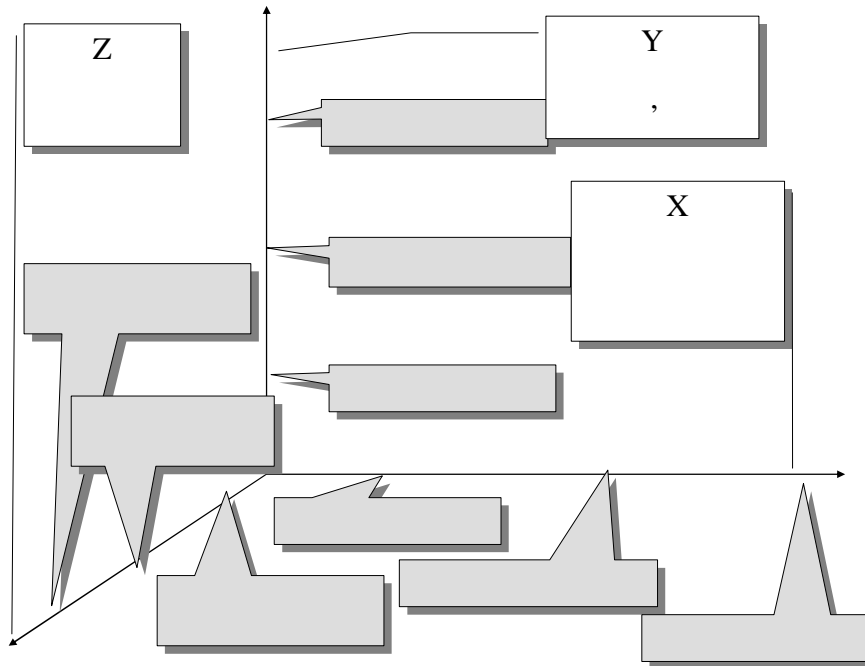

.7.3.

, , -
, . -
, . -
:
- , , -
, ; -

— ,
 , ; ,
 — .
 . —
 .
 , .
 , .
 , (, ,)
 , (, ,)
 , .
 , .
 . ,
 .
 . , ,
 ; ;
 . :
 , ;
 ; ;
 ; ;

• ;
• ;
• .
, , .
, , . : 1)
; 2) , .

4.

, , .
, , .
« »
, :
— , ;
— , , ;
— ;
— ;
— . ,
() , , , .
: .

—), (, —
 ;
 — , , —
 ;
 — ,
 ;
 — , .

(.7.4).

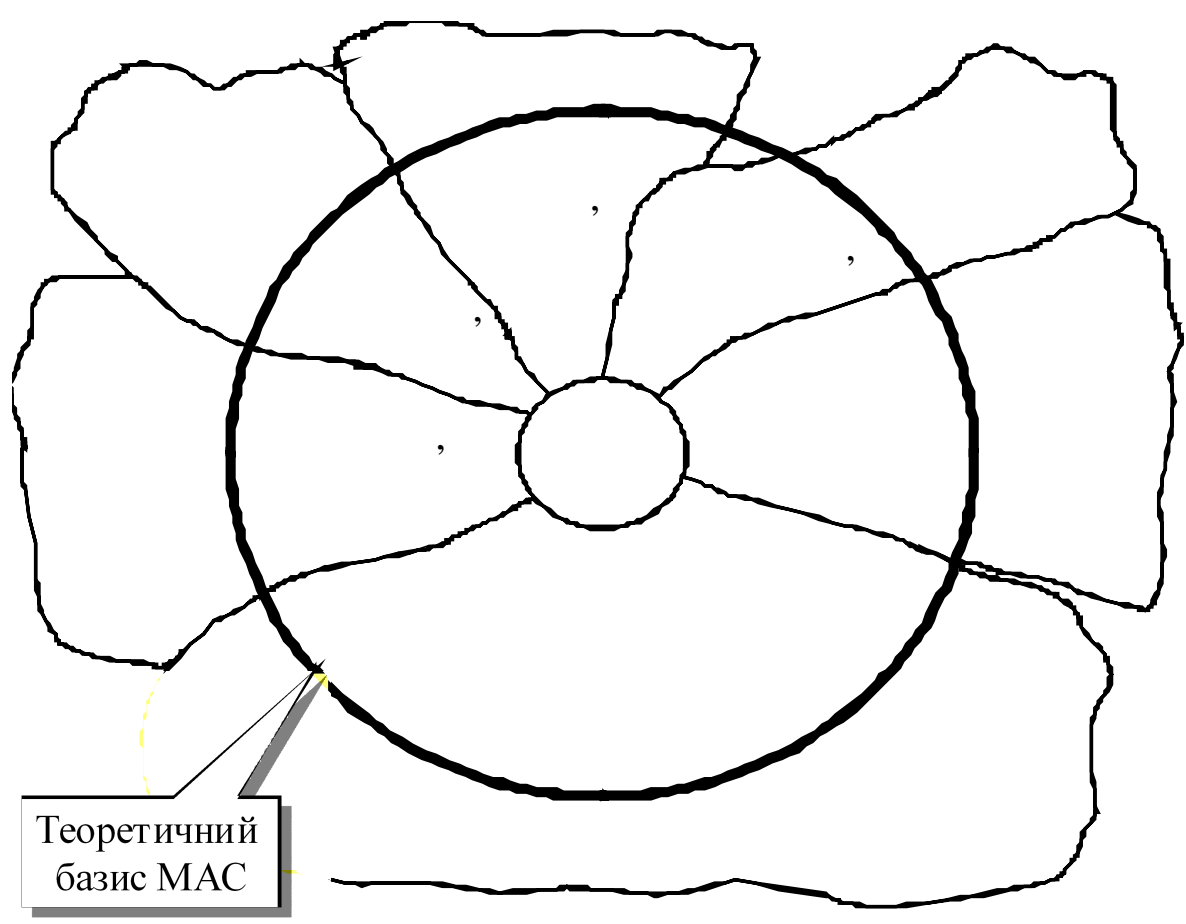

. 7.4.

A

— , , —
· , , —
, , ·
, , —
·
:
;
(, ,);
; ; ·
, :
; ;
— ,
· ,
— ,
· ,
, , —
, , —
(,) . —
·
, ·
:
— ,
; ;
— ,
(,); (, —
) ;
; (—
,);
— ;

(), ;
-
.

, , -
.

()
).

: ;
- ;
- ;
- , .

() ()
-

master-slave client-server.

, , :
-

, , ;
-

()
.

- : -
.

- ;
-

，
'
·
— I, ·
,
-
·
-
·
(,)
-
,
·
:
- (, , -
, ,)
- ;
- ;
- -
, -
· , ,
, ,
·
, -
· , ·
: - ;
, ,
·
,
·

(
) .

— , ;
— ;
— — , —
. .
5.
. ,
, , —
. , —
. , KIF SQL, —
, .
, , —
, . —
. — —
. — , —
, .
« , —
, , ».
— :
— : ;
;

KSE –

KSE

: Interlingua, Shared Reusable Knowledge Bases, External Interfaces. *Intrelingua*

KIF (Knowledge Intrchange Format). KIF

(<http://www.cs.umbc.edu/kse/kif/>). *SRKB* (Shared Reusable Knowledge Bases)

External Interfaces

KIF

. KIF

). KIF

«'» «»,»,

. KIF

KIF ()

KQML –

KQML:

- KQML
- (performatives) –

- KQML,

KQML

- ;
- ;
- .

(KQML

ASCII).

KQML (

,

(

).

KQML
KQML.

(,).

KQML

Data Mining).

\bullet \bullet \bullet \bullet \bullet

(\quad , \quad) .

A_i A_j

A_i $A_j, j = \overline{1, n}$

A_j ;

A_j C_j ;

A_j A_i :

S_k $\langle S_k, P, A_j \rangle$, A_j

A_i $A_j, j = \overline{1, n}$.

(\quad) .

Data Mining

-
-
-
-
-
-
-
-
-

Web-

on-line;

FIPA?

1. ?
2. ?
3. FIPA?
4. ?
5. ?
6. ?
7. ?
8. ?

8 WEB-

1. - .
2. Web- .
3. Web- .
4. .

1. -

- (- COA) - -
,
(), -
COA ,
- . -
,
, , ,
, , -
. - -
, - COA -
- , ,
.
SOA - ,
, -
, ,

,
SOA
50- ;
Web-
SOA ()
SOA - Web-
SOA
Web-
SOA
SOA
SOA
XML-
XML-

2. Web-

Web- 90- XX .

Web-

, IBM, Microsoft, Ariba, Sun

Microsystems, SAP

W3C. W3C

Web Services Architecture Working

Group,

Web-

Web-

XML

-

,

,

. Web-

-

,

Internet. Web-

-

,

-

URI,

XML.

Web-

-

,

,

: SOAP (Simple

Object Access Protocol) -

;

WSDL -

Web-

; UDDI

(Universal Description, Discovery and Integration) -

Web-

.

,

Web-

,

- WSDL-

.

Web-

SOAP,

XML

Web-

.

Web-

-

,

UDDI.

Web-

- UDDI DISCO. UDDI -

-

, a DISCO

.

UDDI -

-

,

Internet.

SOAP

Web-

GET,

POST,

SOAP.

SOAP – Microsoft Internet, (RPC, Remote Proc dure Call) XML. XML, SOAP XML-« » WSDL WSDL – XML W3C. Web- WSDL Web- WSDL Microsoft – SOAP Toolkit 2.0 (WSDL Generator) IBM – WSDL Toolkit. Web- (Web Services Description Language (WSDL)) Web- UDDI UDDI Web- UDDI (UDDI Business Registry), Web- Business Registry, UDDI UDDI Web- OWLS. Web-

3.

Web-

Web-

Web-

Web-

Web-

Web-

WSDL, UDDI),

WSDL,

XML-

Web-

W3C

Web: RDF, RDF Schema, OWL

(. 8.1).

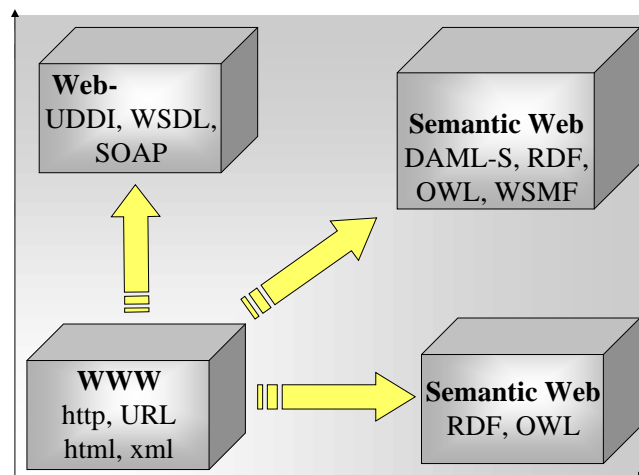

. 8.1.

Web-

OWL-S –

OWL-S

OWL-S

Web-

Web-

Web-

Web-

OWL-S

Web-

OWL-S, Web-

-
-

Web-

(matchmaking).

OWL-S

-

,

,

-

,

,

.

OWL-S

,

,

,

.

4.

OWL-S

Web-

,

,

;

,

,

(*Grounding*),

,

,

.

-

,

,

,

,

Web-

.

-

.

Web-

WSDL,

-

OWL-S,

.

OWL-S

OWL-S.

,

OWL-S

-

,

(*binding*) WSDL.

-

OWL-S.

-

.

UDDI,

-

,

-

,

,

,

-

.

,

,

-

,

.

-

Web-

:

(

,

UNSPSC)

(

,

.).

Web-
 .
 : , -
 , -
 , -
 ; , -
 ;
 ,
 , , -
 , -
 .
 Web- OWL-S -
 Web- : Web-
 , , ,
 .
 , Web- ,
 , .
 -
 OWL – OWL-S OWL-S
 Web- . OWL-S
 ,
 Web- , Web- , -
 . OWL-S -
 Web- -
 , -
 .
 OWL-S – , Web-
 . W3C DAML-S
 ,
 W3C – OWL. OWL-S -
 , , -
 Web- . OWL-S –
 , , -
 , , -
 Web- .

OWL-S (Web Ontology Language for Services) –
 Web- , -
 Web- . OWL-S -
 Web- , -
 Web- -
 . OWL-S -
 Web- , -
 . -
 OWL OWL-S (Web Ontology Language for Services).
 OWL-S Web- .
 OWL-S , -
 Web- ,
 . OWL-S -
 Web- , -
 .
 , , , ,
 . OWL-S – -
 , -
 Web- ,
 .
 OWL-S – ,
 Semantic Web, -
 Web -
 , . Semantic Web –
 , -
 , Web-
 .
 Web, OWL DAML+OIL. -
 () , Web-
 .

OWL-S

()

Web

OWL-S

. OWL-S
Web-

OWL-S

OWL-S

(. 8.2):

: SERVICE

SERVICEPROFILE;

: SERVICE

SERVICEMODEL;

: SERVICE

SERVICEGROUNDING.

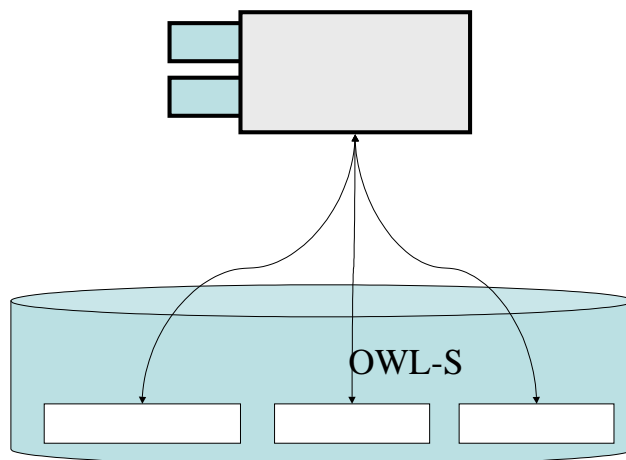

. 8.2.

Web-

OWL-S

SERVICE. OWL-S, Web-

Web-

(matchmaking). OWL-S

OWL-S

1. Web- Web- ,

» , 60, OWL-S,

Web- , ,

2. Web- Web- ,

Web- OWL-S Web- API

Web-

Web-

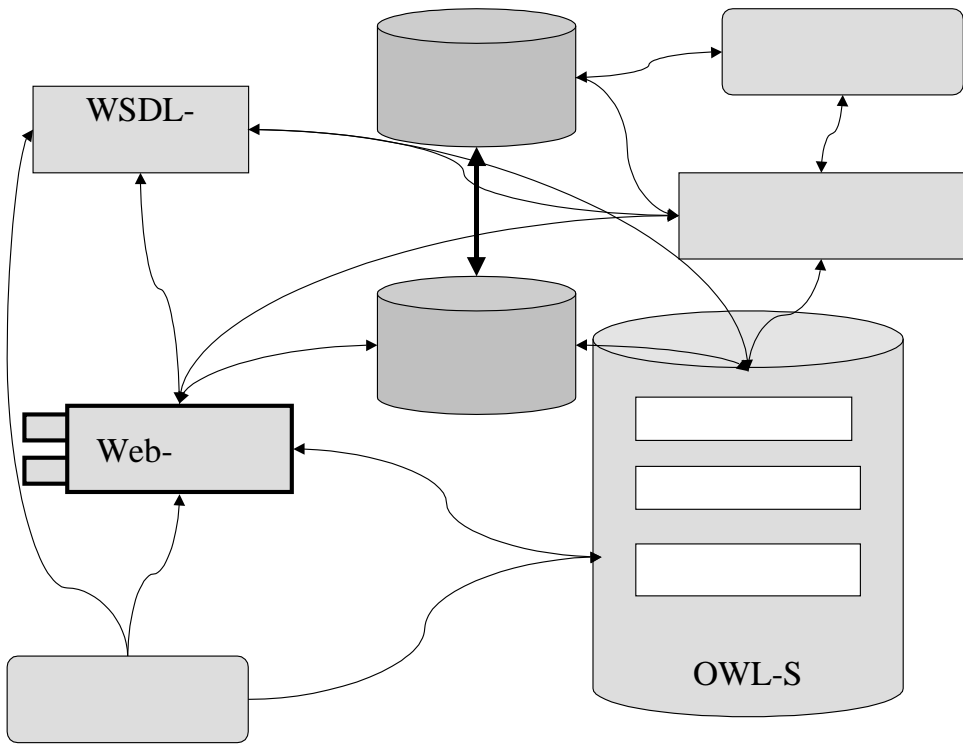

. 8.3.

Web-

	:	.
.	,	,
.	-	-
.		
OWL-S	,	-
,		
		OWL.
		OWL-S
-	,	
,	,	
.		OWL-S
	,	
.		
		Data Mining
	,	

1. Web- ?
2. SOAP XML?
3. Web- WSDL?
4. UDDI Business Registry?
5. Web- ?
6. OWL-S?
7. OWL-S?

- 1.
- 2.
- :
-
-
-
-
-
-
-
-
-
-
- 3.

Fuzzy Logic Toolbox

L . ANFIS-

1.

()

,

—

,

-

.

,

-

(.9.1)

(6.1).

(—)

-

(),

.

,

,

x_i

w_i .

w_i ,

,

-

,

.

,

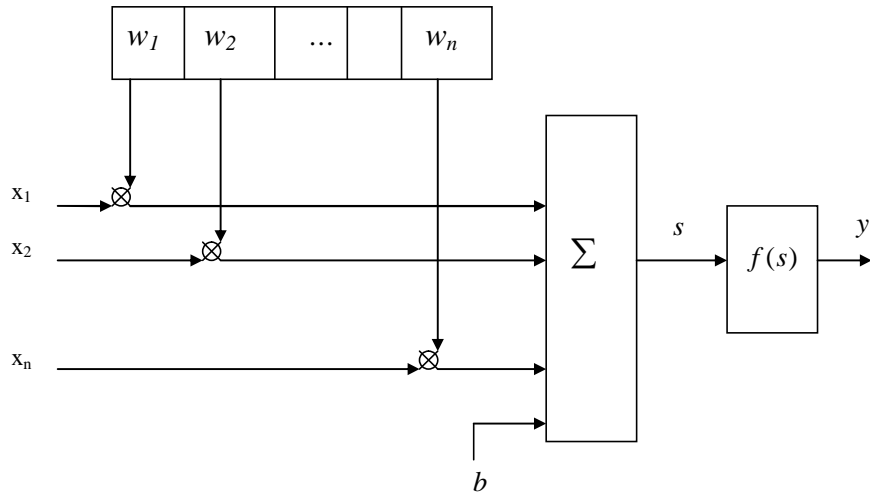

. 9.1.

$$s = \sum_{i=1}^n w_i \cdot x_i + b; \tag{9.1}$$

$$y = f(s),$$

$w_i -$; $x_i -$; $b -$; $s -$ -

$(i \in \{1,2,\dots,n\})$; - ; $n -$

; $f(s) -$ () -

: $w_i, x_i, b \in \mathfrak{R}(i \in \{1,2,\dots,n\})$.

$w_i \in \mathfrak{R}_+(i \in \{1,2,\dots,n\})$, -

$w_i \in \mathfrak{R}_-(i \in \{1,2,\dots,n\}) -$.

$$(9.1) \quad (6.1).$$

$x_i,$

y

$$(9.1).$$

9.1

	\mathfrak{R}	$f(s) = k \cdot s$
	\mathfrak{R}_+	$f(s) = \begin{cases} 0, & s \leq 0 \\ k \cdot s, & s > 0 \end{cases}$
	$\{0, 1\}$	$f(s) = \begin{cases} 0, & s < T \\ 1, & s \geq T \end{cases}$
	\mathfrak{R}_+	$f(s) = s $
()	$\{-1, 1\}$	$f(s) = \begin{cases} -1, & s \leq T \\ 1, & s > T \end{cases}$
	\mathfrak{R}_+	$f(s) = s^2$
	\mathfrak{R}_+	$f(s) = e^{-a \cdot s}$
	$[-1, 1]$	$f(s) = \sin(s)$
()	$(0, 1)$	$f(s) = \frac{1}{1 + e^{-a \cdot s}}$
()	$(-1, 1)$	$f(s) = \frac{s}{a + s }$
()	$(-1, 1)$	$f(s) = \frac{e^{a \cdot s} - e^{-a \cdot s}}{e^{a \cdot s} + e^{-a \cdot s}}$
()	$[-1, 1]$	$f(s) = \begin{cases} -1, & s \leq -1 \\ s, & -1 < s < 1 \\ 1, & s \geq 1 \end{cases}$ $f(s) = \begin{cases} -1, & s \leq -1 \\ s, & -1 < s < 1 \\ 1, & s \geq 1 \end{cases}$
	$[0, 1)$	$f(s) = \begin{cases} 0, & s \leq 0 \\ s, & 0 < s < 1 \\ 1, & s \geq 1 \end{cases}$
	$[0, 1]$	$f(s) = \begin{cases} 1 - s , & s \leq 1 \\ 0, & s > 1 \end{cases}$
()	$(0, 1]$	$f(s) = e^{s^2}$

()

(. 9.2).

()

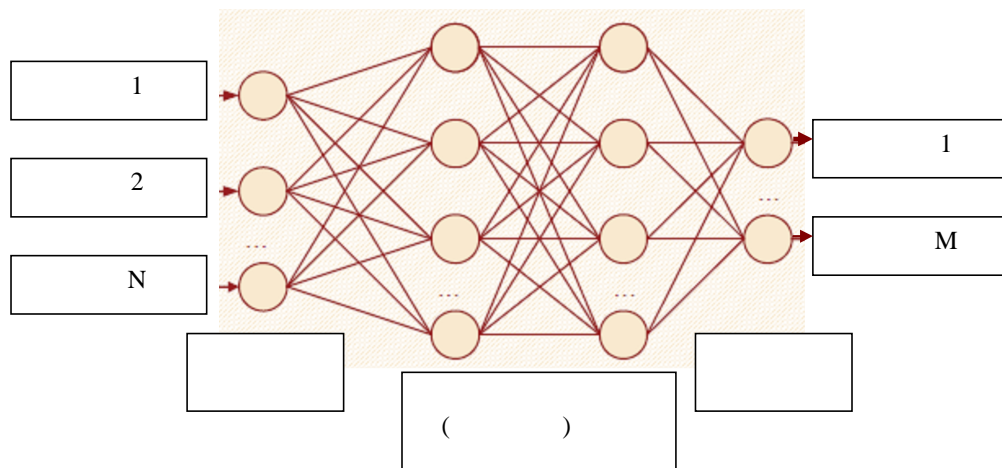

. 9.2.

-
-
-
-
-
-

:

2

:

()

, : .

(. 9.1).

- , — .
- , — .
- .

2.

1) : , -

() ;

2) () -

, ,

3) ; -

(,) ;

4) , -

. , -

, . , -

, . -

. -

, . -

, . -

, . -

. 9.3.

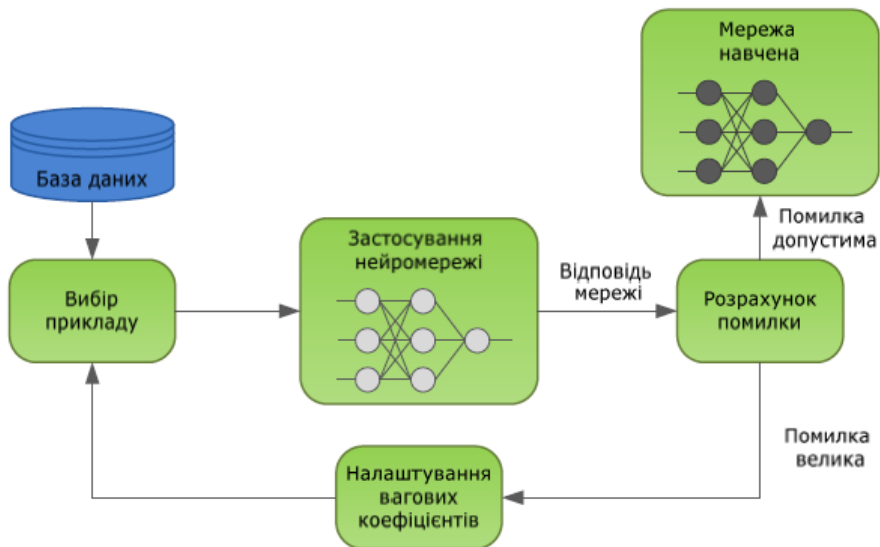

. 9.3.

0 100,
0 100.

, , -

.

, , -

.

,

.

,

-

,

,

,

,

-

,

,

-

.

,

-

[0..1].

-

.

1.

.

-

.

[min..max],

min,

- max.

-

min max.

2.

.

.

,

,

.

-

,

,

,

«

».

,

,

-

-

,

,

.

.

,

-

3.

.

.

.

,

-

,

,

,

.

-

,

-

.

-

,

.

,

1.
[0..1].

-5	0
2,3	0,81111
1,1	0,67778
4	1
3,5	0,94444



2.

	1
	2
	3
	4

3.

[-1..1].

	00	-1	-1
	10	1	-1
	01	-1	1
	11	1	1

- : - -
 - - - . [-1..1].
 . (-),
 () ,
 () ,
 , . :
 , .
 , .
 - ,
 .
 , ,
 , 2, .
 : «
 , ».
 ,
 , .

« » , , .

·

—

,

,

,

,

,

,

,

(),

,

,

.

:

— (

0...1).

« » .

,

.

;

— — 0...1.

0,9 ±0,1;

Resilient Propagation (Rprop) –

», . « ,
4–5 , ,

Resilient Propagation

– – ,
– – ;
– – .
– – ,
– – :
– – ,
– – ;
– – (–),
– – , ,
– – , ,
– – « » ,
– – ;
– – –
– – ,
– – «
– – »;

(Self Organizing Maps – SOM),

k -

(k - means).

SOM

(,)

().

(,)

,)

SOM

SOM

n-

n

).

(

).

SOM

(),

(neighbourhood

)

3.

Fuzzy Logic Toolbox

L

()

(6.1)

[0, 1].

Fuzzy Logic Toolbox

L

ANFIS.

ANFIS

	.	-
L	,	
	–	ANFIS
	FIS	,
1.	L	-
	ANFIS	-
	,	-
Fuzzy Logic Toolbox.		
Fuzzy Logic Toolbox	L	
	.	-
	:	
•	,	-
ANFIS;		-
•		
	L	-
	.	
ANFIS		
	,	
	,	-
	,	
	.	
	ANFIS-	
	ANFIS-	
<i>anfisedit.</i>	,	
	. 6.4.	-
	ANFIS-	,
. 9.4.		

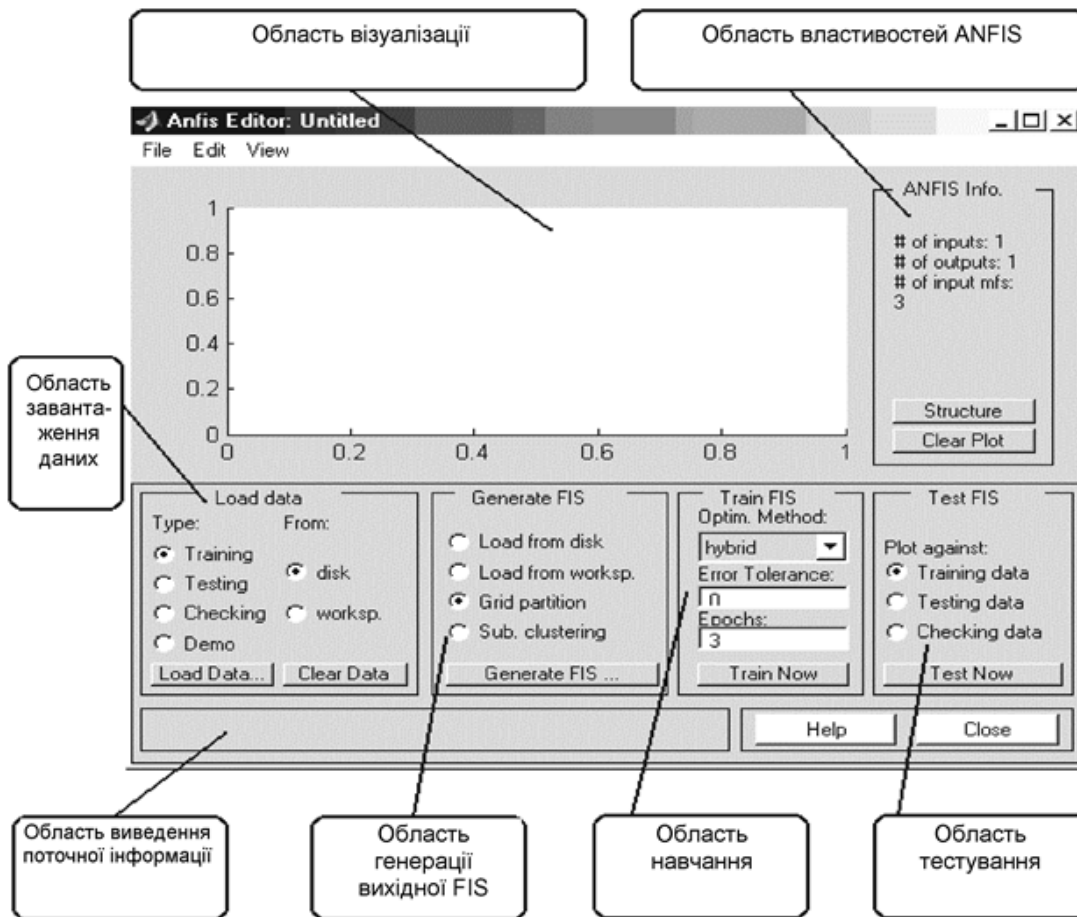

. 9.4.

ANFIS-

ANFIS-

3

– File, Edit View,
ANFIS,

Close,

Help
ANFIS-

Anfis

Edit:

Undo

Ctrl+Z.

FIS Properties...

FIS-

Ctrl+1.

Membership Functions...

Ctrl+2.

```

Rules...
Ctrl+3.
Anfis... ANFIS-
Ctrl+3.
,
ANFIS-
Edit GUI-
ANFIS-
Anfis...,
:
-
;
-
(
,
),
-
:
(.) -
;
(o) -
;
(+) -
(*) -
ANFIS (ANFIS info)
,
,
Structure Clear Plot.
Structure
Clear Plot
(Load data)
:
(Type),
(Traning -
; Testing -
; Checking -
; Demo -
);
(From),
(disk -

```

```

worksp –                               MatLab);                               -
    Load Data...,                       ,                               -
    ,                                     ,                               -
    ;                                     ,                               -
Data.                                     ;                               Clear
    (Generate FIS)                       -
    .                                     -
    : Load from disk –                   -
    ; Load from worksp. –                 -
    MatLab; Grid partition –              -
    (                                     ); Sub. clustering –          -
    .                                     .                               -
    Generate,                             -
    .                                     .                               -
    Load from disk ’                   -
    .                                     .                               -
    Load from worksp. ’                   -
    .                                     .                               -
    Grid partition ’                   -
    ,                                     ,                               -
    .                                     .                               -
    Sub clustering ’                   -
    : Range of influence –                 -
    ; Squash factor –                       -
; Accept ratio –                           ,                               -
    ,                                     ,                               -
    ,                                     ,                               -
    ; Reject ratio –                       ,                               -
    ,                                     ,                               -
    .                                     .                               -

```

(Train FIS) -
 (Optim. method), -
 (Error tolerance),
 (Epochs) Train Now, -

MatLab. ANFIS-
 : backpropa -
 ; hybrid -

(Test FIS)
 Test Now, -

- 1. ? -
- 2. -
- ? -
- 3. ? -
- 4. ? -
- 5. ? -
- 6. -
- ? -
- 7. ? -
- 8. ? -
- 9. -
- ? -
- 10. -
- ANFIS?

9.1

L

$$q = F(x_1, x_2) = 2\sqrt{x_1} \sqrt[4]{x_2},$$

(,) x_1 x_2 -
 q .

1.

1	2	2.37
4	1	4.00
1	4	2.82
5	5	6.68
2	4	4.00
4	3	5.26
3	1	3.46
4	4	5.65
4	2	4.80

«Space»,

«Enter».

work

Matlab6,

train.txt.

,

$m \times (n+1)$,

m

,

–

,

–

L

,

«

» (

<Enter>).

,

,

,

,

.

,

L

,

5–6.

,

,

:

(Training) –

,

,

;

(Testing) –

,

,

;

(Checking) –

,

,

,

;

(Demo) –

.

test.txt.

train.txt

:

2	1	2.82
3	2	4.12
1	3	2.63
2	3	3.72
3	3	4.56
4	2	4.75
3	4	4.90

2.

ANFIS

(. 9.1.1).

Data

(worksp).

(train),

NFIS

().

Load

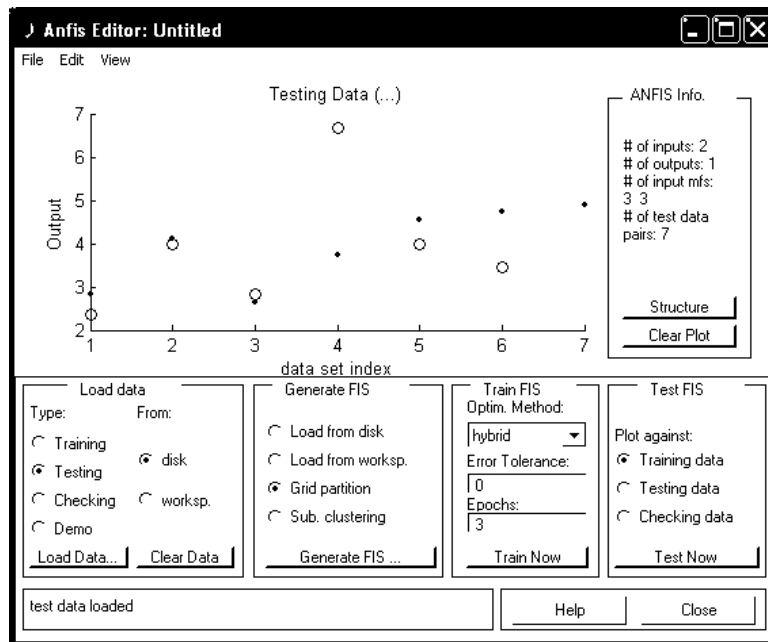

. 9.1.1.

ANFIS

function.dat

testing,

Load data

test.txt.

3.

FIS.

;

;

(Load from disk),

(Load from

FIS

FIS

(Grid partision)

(Sub. clustering).

Generate FIS

(. 9.1.2).

FIS.

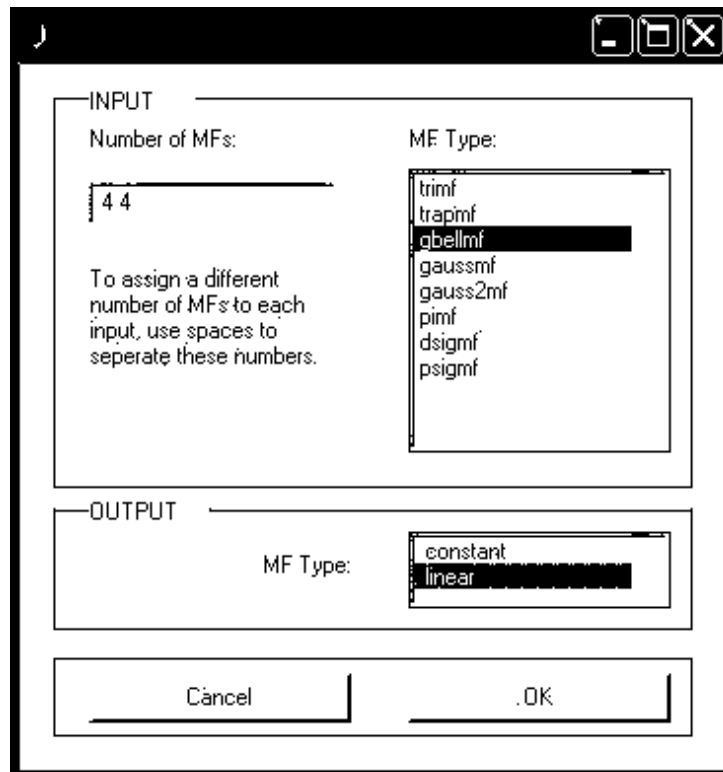

. 9.1.2.

Structure

FIS

4.

1.

(bacpr e)

(hybrid),

2.

(Error Tolerance) –

0 ()

3.

(Epochs) –

3 (

40).

6.

Trian Now.

7.

5.

Fuzzy

Logic Toolbox.

fis,

FIS.

ANFIS.

Editor),

(Membership Function
(Rule Editor),
(Rule

Viewer)
(Surface Viewer).

6.

*.fis
fuzzyToolbox (. 9.1.3).

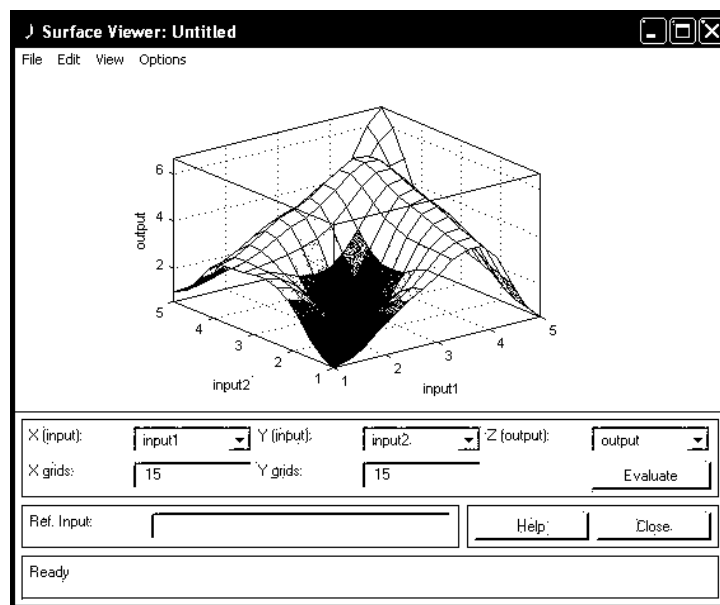

. 9.1.3.

$$q = F(x_1, x_2) = 2\sqrt{x_1} 4\sqrt{x_2}$$

(. 9.1.4).

Input (

, 3 1), <Enter>
 (3.46).
 3.46,
 0 %.

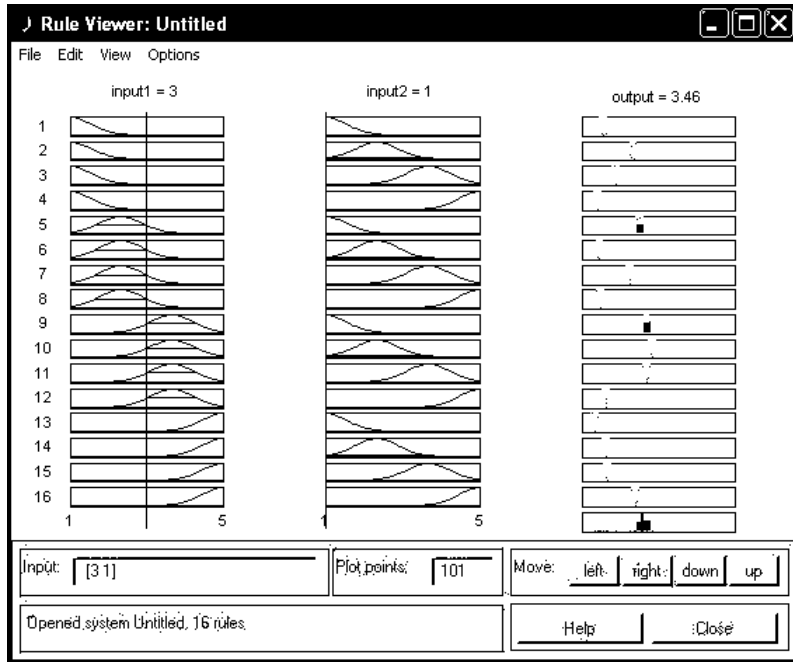

. 9.1.4.

4 3,
 5.45 (5.26).

1.

2.

3.

L .

: 5.45

4 3 (. 9.1.5).

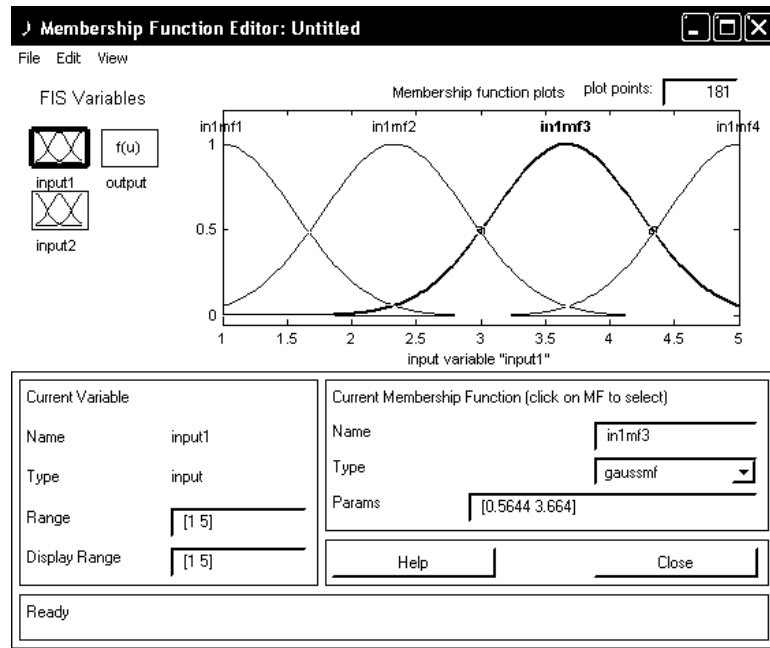

. 9.1.5.

Params

[0.385 3.66]

5.29 (. 9.1.6).

train.txt.

12

2	1	2.82
3	2	4.12
1	3	2.63

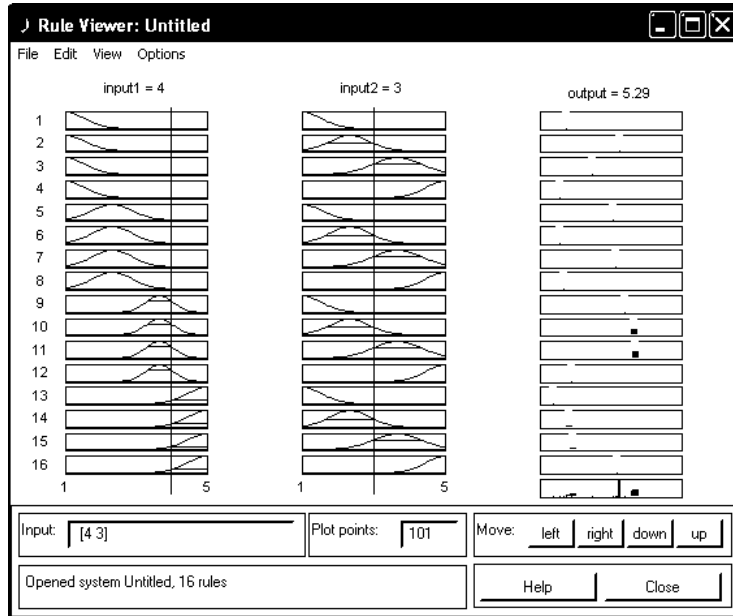

. 9.1.6.

Clear Data

FIS
(gbellmf).

FIS,

i ,
5,

1.

$$y = x^3,$$

. 9.1.7

. 9.1.8.

```
D:\MATLAB6p5\work\function2.dat
File Edit View Text Debug Breakpoints Web Window Help
Stack: Base
1 -2.0 -8.0
2 -1.8 -5.832
3 -1.5 -3.375
4 -1.4 -2.744
5 -1.0 -1.0
6 -0.8 -0.512
7 -0.5 -0.125
8 -0.4 -0.064
9 0 0
10 0.4 0.064
11 0.5 0.125
12 0.8 0.512
13 1.0 1.0
14 1.4 2.744
15 1.5 3.375
16 1.8 5.832
17 2.0 8.0
Untitled function2.dat Ln 16 Col 6
```

. 9.1.7.

ANFIS,

$$y = x^3.$$

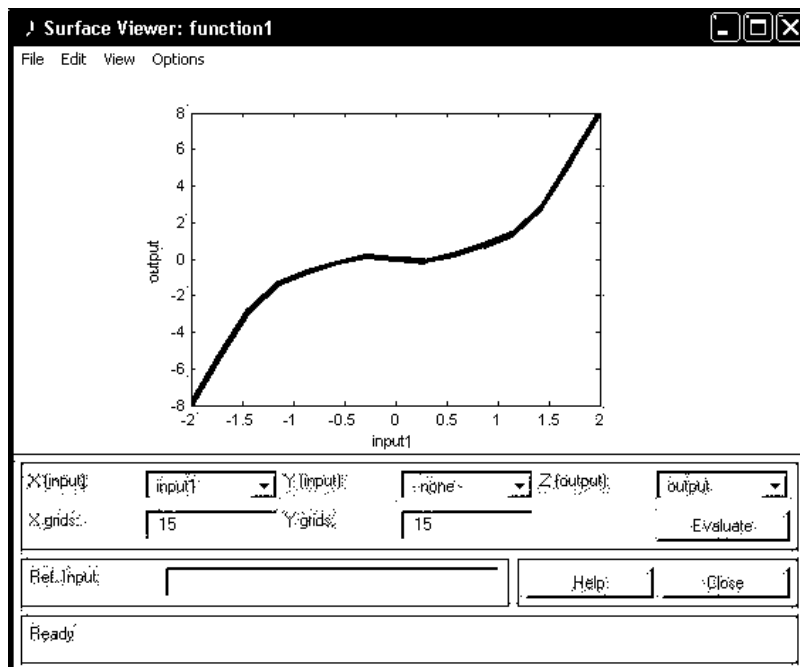

. 9.1.8.

$$y = x^3$$

2.

()

www.blagovest.com.

(. 9.1.1).

9.1.1

N

29.01.N	33	
29.01.N	45	
5.02.N	58	
5.02.N	36	
12.02.N	28	
12.02. N	25	
19.02. N	42	
19.02. N	33	
2.03. N	25	
2.03. N	46	
19.03. N	28	
19.03. N	45	
26.03. N	36	
26.03. N	39	
2.04. N	46	
2.04. N	45	
9.04. N	28	
9.04. N	46	
16.04. N	43	
16.04. N	45	
7.05. N	45	
7.05. N	46	

3
3
4
-7.

1² - (1²)
10

prise.txt. ANFIS,

3 4
L

20.
0,

,

MATLAB

Fuzz Logic lb

evalfis.

```

3
:
out=evalfis ([ 1 2 3], prise),
out - ' ; 1 -
; 2 -
; 3 - ; prise -
, FIS,
L .

```

```

, .
.2,
i
, , , , ,
, ,
.

```

1. . . . :
 , : [] / . . . - :
 , 2011. – 439 .
2. . . . /
 - . : , 2001. –
 384 .
3. . . .
 MATLAB / . . . - : - , 2003. –
 736 .
4. . . .
 [] / . . . - 2002. –
 : [http://www.nsu.ru/matlab/MatLab_RU/fuzzylogic/
 book1/index.asp.htm](http://www.nsu.ru/matlab/MatLab_RU/fuzzylogic/book1/index.asp.htm)
5. . . .
 / . . . - . : « » , 2005. –
 90 .
6. . . . / . ,
 . ; [. . .] . - . :
 2002 – 832 .
7. . . . / . -
 . - . : , 2001. – 288 .
8. . . . tLab / . . . -
 . - - , 2003. – 67 .
9. . . . MATLAB /
 . . . - . : - , 2005. – 640 .

1

1. . . .
 [] / . . . -
 : // [http://www.big.spb.ru/publications/bigspb/km/mnogogr_uz_
 na_predpr.shtml](http://www.big.spb.ru/publications/bigspb/km/mnogogr_uz_na_predpr.shtml)

2. : /
[. . .] . – . : , 2006. – 304 .
3. -
/ . . // -
. – 2009. – 4. – T. 2. –
. 217–220.
4. /
. . . , – : , 2008. – 384 .
5. : [
] / – : , 2010. –
132 .

3

1. -
/ . . . – . :
, 1976. – 165 c.
2. : :
[] / . . . , . . . ,
. . . . – : , 2002. – 113 .
3. -
. / . . . , . . . ,
. . . . – : , 1990. – 184 .
4. -
:
/ – : – , 1999. –
320 .
5. ,
/ . . . , . . . -
. – . : – , 2004. – 452 .
6. -
MATLAB / – . : – ,
2007. – 288 .

9

1. . . :
, : [] / . . . - :
, 2011. - 439 .
2. . ,
/ . , . -
. - : - , 2004. - 452 .
3. . . -
MATLAB / . . . - :
2007. - 288 .

«

»

«
«

»

2001 .

»,

2015 .

,

,

:

. . ,

. .

,

. .

25.01.2016. 60×84/16.

1. «Times New Roman».

. . 11.1.

300

.

541.

-

08200, .

, 31, . ,

,

,

,

4336 12.06.2012 .

«	2002	»	:
«	2003	»	
«	2004	»	
«	2005	»	
«	2006	»	
«	2008	»	
«	2009	»	
«	2010	»	
«	2011	»	
«	2012	»	
«	2013	»	
«	2014	»	
«		, .1»	
«		, .2»	
«		, .3»	

« » 2001 .
« » ,
2015 .

... , ... ()
... , ...
... , ...
... , ...
... , ...
... , ...
... , ...
... , ...

« » :
2015 :
« » : 2-
« - - » :
« - - » :
« » :
« , , » ,
« : , »
« : , »

»
: «Let Developer English skills»

« »
« »
« » :
« » :
« » :

2016

« »
« - - »
« »
« : : »
« : : »
« »
« »
« »

WEB-

« » :
« » :
« : , , »
« » :
« » :
« » :
« » :
« » :

2016

« »
« »
« »
« »
« »
« , »
« : »
« . »
« . I. . »
»

«English grammar for low students»
«Grammar for students of economics»

« »
2012 , », -
« », 2016 .
